

# Luggie<sup>®</sup>

Luggie Series

*~ Smart Fold , Easy Go ~*



**USERS INSTRUCTION MANUAL**



## FOREWORD

Note to the reader:

For your safety and the safety of everyone around you, we ask that you read and follow the suggested rules and regulations outlined in this Owner's Manual.

*Always think safety first!*





## CONTENTS

|  |    |
|--|----|
| Introduction .....                           | 3  |
| Product Description .....                    | 3  |
| Luggie Feature Guide .....                   | 4  |
| About Your Luggie Scooter .....              | 4  |
| Guidelines For Safe Use .....                | 5  |
| Getting To Know Your Luggie .....            | 7  |
| Operating Your Luggie .....                  | 8  |
| Freewheeling Your Luggie.....                | 12 |
| Safety Instructions And Warnings .....       | 13 |
| Safety Warnings And Instruction Labels ..... | 18 |
| Learning To Get Around .....                 | 19 |
| Transporting Your Luggie .....               | 22 |
| Battery And Battery Charging .....           | 23 |
| Frequently Asked Questions.....              | 25 |
| Lithium Battery Installation .....           | 30 |
| Care And Maintenance .....                   | 31 |
| Basic Fault Finding .....                    | 35 |
| Technical Specification .....                | 38 |
| Size Specification-Luggie .....              | 40 |
| Luggie Armests Installation Guide .....      | 41 |
| Advisory Safety Notices .....                | 42 |
| Optional Accessories .....                   | 43 |
| Warranty Terms .....                         | 44 |
| Service Record .....                         | 46 |



## INTRODUCTION

Congratulations on the purchase of your Luggie scooter! Please read this User Instruction Manual carefully before you attempt to operate your scooter. Your User Instruction Manual is your guide to safe operation and maintenance of your Luggie scooter.

Before beginning to use your scooter, make sure you completely read and understand all instructions thoroughly. Please observe the "Guidelines For Safe Use" and the Safety Instructions and warnings outlined on page 5-6 and 13-17 of this owner's manual. If you have any questions concerning operation or maintenance, consult your Authorized Luggie Dealer.

Please keep in mind that the operator of the scooter is responsible for accidents or hazards to other people and/or their properties.

Your Luggie has numerous features not found on other power scooters. With proper care and maintenance, you will enjoy many years of dependable service from your Luggie scooter. Your Luggie scooter needs to receive proper maintenance at regular intervals and should be inspected frequently for proper mechanical operation. Troubleshooting guidelines, methods of detecting improper operation and how to make minor adjustments are included in this manual.

Follow all recommendations to obtain trouble free, safe and enjoyable operation of your Luggie scooter. Please remember that when it comes to service and repairs, consult your Authorized Luggie Dealer.



## PRODUCT DESCRIPTION

Luggie standard features:

- Rear-wheel drive via sealed drive axle.
- Lithium-ion battery.
- Standard charger adapter.
- Seat with folding backrest and adjustable height.
- A multi-positional handlebar for greater maneuverability.
- A simple 'wig-wag' type control lever situated in front of the handlebars when you are seated which control speed, braking and direction.
- Independent braking systems.
- 'State of the art' micro-controller electronics ensures a smooth, comfortable and safe drive on most surfaces and gentle slopes no more than 6 degrees.
- One piece aluminum alloy chassis for ease of transportation.
- Your scooter can be easily folded without the use of tools, making transport a breeze.
- Battery pack can be easily removed and replaced.

- Note: Your scooter is not designed to transport the user in a moving vehicle i.e. train or cruise ship. Consult with your Authorized Luggie Dealer or transportation agent for further details.

The Luggie should be serviced by an Authorized Luggie reseller to ensure safe, reliable operation. For details and a list of options available for Luggie scooter, refer to the accessories section of this manual (page 42).

## LUGGIE SCOOTER LABELED

1. Top Console
2. Wig-Wag lever
3. Speed Control Knob  
Turtle(slow)  
Rabbit(fast)
4. Tiller Adjustment Clamp
5. Tiller
6. Trigger
7. Transport wheel
8. Front Bumper
9. Front Solid Tire
10. Slip Resistant Mat
11. Tiller Locking Clamp
12. Chassis Locking Release Ring
13. Chassis Hook
14. Charging Socket
15. Battery Release Button
16. Lithium Battery
17. Magnetic Brake Release
18. Seat Lock Handle
19. Rear Solid Tire
20. Rear Bumper
21. Seat Lock Indicator  
(both red when properly locked)
22. Lifting Handle
23. Base of Seat
24. Armrest
25. Backrest of Seat



## ABOUT YOUR LUGGIE SCOOTER

⚠ The Luggie scooter is made for mobility challenged and pre-mobility individuals looking for mobility independence in a comfortable, reliable, easy to maneuver and easy to maintain scooter. The intended user will need to possess some degree of ability in the use of his/her arms and hands, reasonable balance and eyesight, and a degree of spatial mobility. It is also advisable that the user receive training in the



a degree of spatial mobility. It is also advisable that the user receive training in the use of the product, preferably in their normal environment before use. The maximum user weight capacity for the Luggie can be found in the rear of this manual, under 'Technical Specification' (page 38-40).

Your Luggie is suitable for indoor or outdoor use: in your home, shopping malls, precincts and on dry, smooth level surfaces. It climbs slopes safely up to 6 degrees and over obstacles up to one inch (2.5cm).

Your Luggie scooter is a 'Class 2' (B) \* vehicle and designed for pavement use only. The Luggie must only be used on roads with caution if a sidewalk is not available. It is designed for a single occupant who experiences difficulty or discomfort when walking for prolonged periods, but has the use of visual and cognitive ability to operate the scooter safely.

Do not drive your Luggie if you are under the influence of alcohol, drugs or medication that may affect your physical or cognitive abilities. If in doubt consult your Physician. As a motorized pedestrian, user should familiarize himself with the current legislation contained within the Highway Code.

---

\* Electrically powered scooter is classified in the following categories:

- Class 2 as defined in "The use of invalid carriages on the Highways Regulations 1988": A scooter type invalid carriage designed for the use on the sidewalk, with maximum speed up to 4 M.P.H.
- Class 'B', as defined in the United States Standard CU and The European Standard EN12184 1999: A scooter sufficiently compact and maneuverable for some indoor environments and capable of travelling over longer distances and negotiating outdoor obstacles.



## GUIDELINES FOR SAFE USE

These symbols below are used in this owner's manual to identify warnings and cautions. It is very important for you to read and understand them.

**⚠ Warning** : Failure to obey and follow the warnings in this User's Manual may result in personal injury.

**⚠ Caution** : Failure to observe the cautions in this User's Manual may result in damage to your scooter.

Your Luggie is a powerful electronic device, for your safety and the safety of bystanders, please read instructions outlined in the manual. Always be certain your scooter is in full working order before starting your journey. Follow notes listed below carefully to ensure safety at all times.

1. DO NOT ride your Luggie without reading this instruction manual. Also read all of the safety instructions and Warnings stated on page 13-17 of this manual.
2. ONLY drive your Luggie if your health condition will allow you to be safe.
3. DO NOT exceed the maximum safe gradient outlined for your vehicle (see Technical Specification, page 38-40).

**⚠Warning :** For your safety, ALWAYS have the anti-tipping wheels properly fitted on your Luggie (FIG 12, page 21).

4. DO NOT carry passengers or exceed the maximum carrying weight. (See Technical Specifications page 38-40).
5. DO NOT mount or dismount your Luggie unless it is switched off with the magnetic brake release disengaged - brakes locked.
6. DO NOT switch your Luggie 'on' with the forward/reverse lever (wig-wag) depressed.

**⚠Warning :** DO NOT hang bags or other belonging over your steering handlebars as this may interfere with your controls. Failure to observe this warning may result in injury to yourself, bystanders, your scooter and properties.

7. DO NOT reverse your Luggie onto uneven inclines or surfaces. Be cautious when traversing slopes. DO NOT attempt to drive on slopes with incline greater than 6 degrees. Not adhering to this warning may result in injuries to yourself and bystanders.
8. DO NOT drive your Luggie in a confined space unless the speed control dial is set to turtle mode or slow setting.
9. DO NOT turn suddenly at full speed, especially on uneven grounds or slopes. Not adhering to this warning may result in the scooter overturning.
10. DO NOT drive your Luggie where you cannot safely or legally walk. OBEY THE HIGHWAY CODE.
11. DO NOT drive your Luggie over deep, soft terrain (ie. soft earth, sand, tall grass, loose gravel or snow).
12. DO NOT drive when under the influence of alcohol or drugs which may impair your safety.
13. Avoid climbing or descending curbs. You may permanently damage the scooter and yourself. ALWAYS use ramps where available.
14. ALWAYS approach small obstacles "straight on" and at slow speed.
15. ALWAYS keep your feet on the vehicle when driving.
16. ALWAYS proceed carefully while riding, especially as you approach the downgrade of a ramp.
17. ALWAYS avoid uneven surfaces.
18. ALWAYS consult your physician if in doubt about your ability to operate the Luggie scooter safely.
19. When transporting your scooter, DO NOT sit on your Luggie while it is in a moving vehicle. ALWAYS strap down your Luggie and transfer to the vehicle seat. For additional details ask the transportation authority of travel for further assistance.

20. DO NOT attempt to remove the seal on the side of the battery. Failure to observe this warning will invalidate your battery warranty.
21. DO NOT drive your Luggie through deep water or clean the scooter with a power washer or compressor hose.
22. DO NOT drive your Luggie through sand or sea water. This is very corrosive for the scooter and will cause permanent damage.

*Please have a safe journey!*

## GETTING TO KNOW YOUR LUGGIE



*Luggie*<sup>®</sup>

Your Luggie scooter is delivered in a strong carton or in the suitcase if you purchased this option. When unpacking the carton, remove and dispose of all of the sharp metal staples which are located on the top to avoid injury. Remove all packing materials and follow the steps outlined in the Quick Start Guide shipped with your Luggie scooter.

We recommend you keep the outer box, packing inserts and battery box for future transport use. Safely dispose of all other packaging materials. If you need assistance with disposal, contact your local waste disposal authority for advice on properly disposing methods.

Your Luggie Scooter is delivered fully folded. Follow the Quick Start Guide included with your scooter shipment before operating your scooter. A full technical specification of your Luggie can be found at the rear of this manual.

A great deal of thought and consideration have gone into the design of your state-of-the-art, life-changing Luggie scooter. Your Luggie will help increase your mobility; thus, give you more time to enjoy life.

The Luggie scooter is a compact, three wheeled vehicle will allow you to navigate obstacles in confined areas. Aside from this, your scooter offers the following:

**COMFORT** - The contoured seat helps cushion you from vibrations of your journey, giving you maximum comfort. The Luggie comes with a speed controller which delivers you a smooth jerk-free ride. For added peace of mind, the Luggie comes with an automatic braking system.

**VERSATILITY** - The Luggie seat assembly has 3 height adjustments (locked & 2 additional height adjustments) for added comfort and versatility. The steering column (tiller) has multiple height adjustments controlled by the trigger. Use the trigger.



Use the trigger to adjust the tiller to the most comfortable angle for and to fold up and down the tiller for ease of transport.

**SERVICE** - Your Luggie has been designed to be service friendly. Sealed lithium battery which is virtually maintenance-free will give your Luggie the power it requires. Should you need to take your battery pack on an aircraft, use the battery box originally shipped with your Luggie scooter for transport. The battery box has been specially designed to safely carry lithium battery of this size in accordance with the International Air Transport Association (IATA). (Please consult your carrier of choice for additional details).

**SAFETY** - The speed controller has been designed with extensive self-checking circuits to give you the maximum 'state-of-the-art' safety technology. The

Luggie comes with a fully automatic braking system for peace of mind in any environment.

**CHARGING** - Your Luggie is fitted with a battery indicator on the top console. When the battery meter is in the red zone, it is advised that you charge your battery. Follow the Battery & Battery Charging guidelines outlined on page 23-30 of the manual.

**⚠ Caution** : DO NOT power off when you are moving; this will automatically activate the motor parking brake and could place you in a dangerous situation.

Your Luggie is fitted with anti-tipping wheels in the rear of the scooter. DO NOT remove these anti-tipping wheels. They are an important part of the Luggie designed specifically for your safety. They help protect against backwards tipping on excessively sharp inclines.



## OPERATING YOUR LUGGIE

Before setting out on your Luggie, you need to make sure that your seat is in the correct riding position. Set the seat to your desired height for your needs.

### UNFOLD LUGGIE SCOOTER

1. Make sure your Luggie is on flat ground before adjusting the height of the seat. With the scooter upright as shown in (FIG 1), pull the chassis locking release ring to your scooter to separate the front and rear chassis. Once the front and rear chassis are disengaged, guide the scooter down by holding the base of the seat with both hands. Refer to the enclosed Quick Start Guide for additional details. Your scooter should now look like (FIG 2) when unfolded.



FIG 1



FIG 2

2. Pull backward on the seat lock handle to adjust the height of the seat while simultaneously lifting the seat. (FIG 3).



FIG 3



FIG 4

**Note:** Please make sure that the seat is properly locked and secured before sitting on the Luggie. There are two windows on either side of the seat lock handle that will appear **red** when the seat is locked and properly secured. Securing the seat adjustment will help prevent accidents or tilting of the seat.

3. Fasten the chassis hooks or security locks on **each side** of the joint of front and rear chassis (FIG 4)
4. Release the tiller locking clamp (FIG 5).
5. Pull the trigger outward to raise the tiller to a comfortable position (FIG 6).



FIG 5



FIG 6

6. Flip the seat back up.
7. Refer to the Quick Start Guide to install your battery. Slide the battery against the inside edge of the battery compartment before pressing it into place.

**⚠ Warning :** If the installed Luggie battery has been idle for a long period, the battery may be in a low power state.

**⚠ Warning :** The best practice is to remove the battery when transporting the scooter so as not to accidentally power on the scooter which cause injuries and drain the battery.

**⚠ Warning :** Armrest Installation (optional): If your purchase comes with armrests, refer to the Luggie Armrest Installation Guide included with your scooter order. Insert and screw the adjustment knobs on the bottom side of the back of the seat assembly.

**Note :** The knobs do not need to be screwed on too tightly. These knobs are pull-pin knobs for you to adjust the width of the armrests.

**⚠ Caution :** The backrest of your seat will not fully fold forwards if the armrests are positioned too closely towards one another.

**⚠ Warning :** When the scooter is in operation, the armrests should not be in the raised position.

## TILLER ADJUSTMENTS

1. The tiller of your Luggie is designed to allow you to position the handlebars in a comfortable driving position. It can be locked into numerous positions for your comfort and ease of transport.
2. To adjust the angle of the tiller (angle the handlebars), locate the trigger as pictured in (FIG 6). Pull the black lever (trigger), outward to adjust the angle of the tiller. To lock the tiller in your desired position, simply release the trigger or the black lever.

## HANDLEBAR ADJUSTMENTS (Luggie Elite)

1. The handlebars of your Luggie Elite is designed to adjust in width for added comfort when driving.
2. To adjust the handlebars of your Luggie Elite simply pull the grips outward on either ends, turn forward and let go to lock.
3. To re-adjust the handlebars to its shorten position reverse the steps above.

**⚠ Warning :** ALWAYS retract the handlebars (shorten position) before folding the tiller down to the locking clamp.



FIG 7



FIG 8



FIG 9

**⚠ Warning :** ALWAYS make certain the trigger or black lever on the tiller is fully down in a locked position and the tiller height is securely locked in place before driving your scooter. To make service adjustment to these parts, refer to the Care and Maintenance section of this manual (page 31-35).

**⚠ Caution :** DO NOT power off the Luggie when your scooter is moving. Failure to observe this warning will result in sudden braking of the motor brake and place you in a dangerous situation. You should only power off your scooter while in motion in the case of an emergency. Continual use of powering off to stop may cause undue stress to the drive system and damage the main electronics. Be extremely cautious on slopes. Sitting upright in your seat allows for greatest stability on your scooter.

The controls of your scooter are located on the top console in front of the handlebars when seated on the Luggie.

1. **Status Light:** The power switch on your Luggie doubles as the status light indicator. When the Luggie is powered “on”, the light on the switch will be illuminated as a solid for the entire duration of the “on” state. When your battery run low in power, the status light will flash slowly at one flash per second. This is the scooter’s way of telling you that it is low in fuel and a charge is needed. If you notice the status light flashing at two flashes per second, you are being notified that the battery voltage is too low to drive. You must stop using your scooter at the earliest opportunity when this happens. There is a total of nine

status light flashing diagnostic signals for the Luggie, refer to Basic Fault Finding section in the rear of this manual for reference.

**2. Battery Indicator:** The battery indicator is located on the top console between the handlebars. When your scooter is switched on, the indicator on the gauge will move across the scale from the left 'red' sector towards the 'green' sector, indicating the state of charge of your battery. As the power is used up the indicator will move towards the red sector indicating the state of charge at that precise time. When the indicator is fully over to the right (green sector), the battery is fully charged. When the indicator falls in the red sector your battery is low in charge and need to be re-charged. Refer to the battery and battery charging section for further details.

**Note :** When driving up a slope or similar obstacles your Luggie motor will be working harder than usual, the battery gauge will move into the red sector. The indicator on the battery meter will regulate to actual charge once the load on your motor is reduced. In conditions listed above, the battery indicator gauge is not a true indicator of amount of charge left on the battery.

**3. Speed Adjustment Dial:** The speed control dial allows you to select the speed of travel, turtle mode or rabbit mode. Adjustments can be made as you travel.



FIG 10

**4. Forward, Reverse Control (Wig-Wag) Lever:**



FIG 11



FIG 12

The wig wag control lever is located on the top console in front of the handlebar as seen in (FIG 11). Gripping on the right lever will move your Luggie in a forward direction. Gripping on the left wig-wag lever will move the Luggie in a reverse direction. To stop, simply release the wig-wag lever.

**⚠ Warning :** Do not hang bags or other belongings over the steering handlebars, doing so may interfere with the movement of your control lever. Failure to observe this warning could put you in a dangerous situation.

**Note :** Your Authorized Luggie Distributor can modify your vehicle for left-hand operation use if requested.

**⚠Warning :** If you are not an accomplished outdoors powered vehicle driver, we strongly recommend that you first practice in an open, safe area, free from traffic, preferably with a care provider who can assist you.

**5. Sleep Time:** When your Luggie scooter has been idle for 15 minutes or more, it will automatically go into sleep mode to conserve battery charge. There are 2 ways to wake the Luggie in sleep mode. One way to wake Luggie is to toggle the wig-wag a couple of times. The recommended way to wake the Luggie is to power off the scooter before powering it back on.

**You are now ready to go. Always think safety first! Enjoy your new Luggie scooter!**

## **FREEWHEELING YOUR LUGGIE**

Your scooter is equipped with a manual freewheel device for your convenience when you need to push the scooter.

### **FREEWHEEL PROCEDURE**

- To put your scooter in freewheel mode, locate the magnetic brake release (red handled lever) located in the rear right hand side of your scooter under your seat as pictured. (FIG 13).
- Make certain the Luggie power switch located under the right handlebar, (FIG 11) is switched off.
- Push forward the magnetic brake release (red handled lever) (FIG13) until a distinct click is felt to disengage the magnetic brake. You can now push your Luggie with ease.

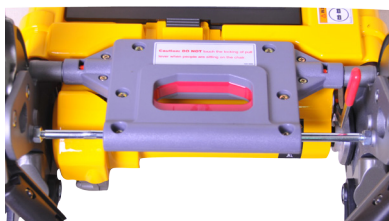

**FIG 13**



**Note:** When your scooter stops in the freewheel mode while pushing, it is not stuck or broken. The safety feature on the scooter will automatically trigger when the scooter is pushed quicker than a slow walking speed. To engage the drive system, simply pull the magnetic brake release lever backwards until a distinct click is felt. If the power switch was left on while in freewheel mode, simply power off and then on to enable driving mode.

**⚠Warning :** Do not sit on your Luggie scooter with the freewheel device in the disengaged position. Your Luggie scooter has limited braking while in freewheel mode.



**⚠Warning :** If your Luggie scooter is in the freewheel mode, you will not be able to drive. Dismount and re-engage the drive system by pulling back on the magnetic brake release (red handled lever). Remount your scooter. Switch the power off and on to clear the fault. Your Luggie will now drive again.

**⚠Warning :** Do not use your Scooter in the freewheel mode without an attendant present. Personal injury may result.

**⚠Warning :** Do not attempt to personally disengage your scooter in the freewheel mode while seated on the scooter. Personal injury may result. Ask an attendant for assistance.

**⚠Warning :** Do not place your scooter in freewheel mode while on an incline. The scooter could roll uncontrollably on its own, causing personal injury.

**⚠Warning :** Always double check that the freewheel device, magnetic brake release lever is disengaged or in the drive position before attempting to drive your scooter after it has been left unattended for a period of time. Failure to observe this warning may result in an accident.

**General note:** If you are able to push your Luggie while in the drive mode, the drive system may be disconnected. Do not attempt to drive your scooter.

**⚠Warning :** Do not leave your scooter unattended when the magnetic brake release lever is disengaged. In this state your scooter may roll away causing damage to others and their properties. Always engage the magnetic brake release when left unattended.

***Please take extreme care when using your Luggie.***



## SAFETY INSTRUCTIONS & WARNINGS

**⚠Warning :** Do not attempt to operate your new Luggie scooter for the first time without completely reading and understanding all of the facts in this User's Manual. Your Luggie scooter is a state-of-the-art device designed to enhance and increase your mobility. If you have a medical condition, it is recommended for you to practice driving in the presence of a trained attendant. A trained attendant can be defined as a family member or care professional specially trained in assisting the scooter operator in various daily living activities. When you begin to use your Luggie scooter, you will probably encounter situations in which you will need some practice. Simply take your time and you will soon become confident and in control as you maneuver through doorways, on and off elevators, up and down ramps and over moderate terrains. Below are some tips, precautions and other safety measures that will help you become accustomed to the safe operation of your Luggie scooter. Your Luggie

scooter is fitted with a number of safety warning & instruction labels, see page 18. These labels communicate important warnings. Please familiarize yourself with their locations on your scooter.

### **SAFETY CHECK**

Get to know the feel of your Luggie scooter and its capabilities. We recommend that you perform a safety check before each use to make certain your scooter operates smoothly and safely. For details on how to perform these necessary inspections, see the Care and Maintenance section of this manual. Perform the following inspection prior to using your Luggie.

- Check the contact area of the battery. Make certain they are serviceable and not corroded.
- Check that your battery has been fully charged.
- Check your scooter brakes. Ensure the scooter is not in freewheel mode.

**⚠ Warning :** Do not carry passengers on your Luggie. Your scooter is designed for a single occupant. Carrying passengers on your scooter may result in personal injury and/or property damage.

### **WEIGHT CAPACITY**

Your Luggie Scooter is design for a maximum user weight limit of 114kg(250 lbs,17.8 stone),Luggie Elite is design for a maximum user weight limit of 145kg(320 lbs,22.8 stone).

**⚠ Warning :** Do not exceed the weight capacity of your scooter. Doing so will invalidate your warranty and may result in personal injury and/or damage to your scooter. Luggie will not be held responsible for injuries and/or property damage resulting from failure to observe these weight limitations. Please also remember that carrying heavy objects will increase your total weight and may make your scooter unstable.

### **CORNERING**

Excessively high cornering speeds may result in tipping. Factors which affect the possibility of tipping include, but are not limited to, cornering speed, steering angle (how sharply you are turning), uneven surfaces, inclined surfaces (such as heavily cambered pavements), riding from an area of low traction to an area of high traction (such as passing from grass areas to a paved area - especially at high speed while turning), and abrupt directional changes.

**⚠ Caution :** Do not corner at high speed! If you feel that you may tip over in a corner, reduce your speed and steering angle to prevent your scooter from tipping.

**⚠ Warning :** When cornering sharply, reduce your speed. When using your Luggie at higher speeds, anticipate changes in the road surface. This will greatly reduce the possibility of a tip or fall. To avoid personal injury or property damage always exercise common sense when cornering.

## BRAKING

Your Luggie scooter is equipped with two powerful brake systems:

1. Regenerative: This uses the electricity generated in your Luggie drive motor to rapidly slow your scooter when the wig-wag lever is returned to the stop position.
2. Electric/Mechanical Disc Brake: This activates mechanically after the regenerative brake slows your scooter to a near stop, or when power is removed from the drive system. Brake engagement is far more abrupt at higher speeds. It is important that you anticipate when the brakes will engage and that you are braced for the resulting deceleration.

**⚠ Warning :** Your Scooter can decelerate very quickly. Do not decelerate or turn abruptly when travelling at high speed unless absolutely necessary. Always grip the steering handlebars tightly and position your feet firmly on the floor board of the scooter. Operators who cannot grip the handlebars tightly and/or place their feet firmly against the floorboard should avoid traveling at high speed. Failure to observe this warning could result in serious personal injury and property damage. Always brace yourself firmly when decelerating your Luggie scooter.

**⚠ Caution :** Never drive down slopes at full speed. Always adjust your speed to the driving condition and allow for gradual descents on inclines no more than six degrees.

## OUTDOOR DRIVING SURFACES

Your Luggie Scooter is designed to provide optimum stability under normal driving conditions i.e. dry, level surfaces composed of concrete or asphalt. There will be times when you will encounter other surfaces such as packed soil, grass and gravel. These surfaces may not be sound and fail to give good traction, caution should be considered before driving on these types of surface to prevent stability problems resulting in injury or damage to you and your scooter. Always reduce your scooters speed when driving on uneven terrain or soft surfaces by turning the speed control knob (located on the left side of the top console) away from you while seated (toward the turtle mode).

**⚠ Caution :** Avoid driving in long and unsafe grass that can become tangles in the gears of your scooter.

**⚠ Caution :** Avoid snow. This can quickly build up around your wheels.

**⚠ Caution :** Avoid loosely packed sand and gravel. If you feel unsure about a driving surface, please avoid that surface. Your scooter is a motorized device. Use your good judgment when traveling to avoid injury and damage to yourself, the scooter and properties of others.

## STREET AND ROADWAY DRIVING

**⚠ Warning :** Your Luggie scooter has not been designed for operation on public streets and roads such as pavements and traffic free shopping areas. Your Luggie must be driven with care and compliance with Highway Code. Always obey all local pedestrian traffic rules. Wait until your path is clear of traffic before proceeding with extreme caution.

**Note:** Always wear bright or illuminating clothing when driving your scooter. Be aware that it may be difficult for pedestrians and other motorized vehicles to see you when you are seated on your scooter. Only drive your scooter on the road when public pavements or sidewalks are not available (i.e. in the countryside) or when crossing the roadway from one pavement to another.

## INSURANCE

Although it is not a legal requirement for accident insurance coverage (third party), it is a sensible precaution. Your Luggie Authorized Dealer will be able to give you details of specialist insurance companies or your own insurance company will be able to advise you.

## WEATHER PRECAUTIONS

**⚠ Warning :** Do not operate your scooter in icy or slippery conditions or on salted surfaces i.e. roads and pavements. Such use may result in accident, personal injury or adversely affect the performance and safety of your scooter.

**⚠ Warning :** It is recommended that you do not expose your scooter to any type moisture at any time i.e. rain, snow or power washer. Such exposure may damage your scooter. Never drive through deep water or expose your scooter to sea water. Do not operate your scooter if it has been exposed to heavy moisture until it has been thoroughly dried out.

## MOTOR VEHICLE TRANSPORTATION

Currently there are no standards approved for "tie down" systems in a moving vehicle of any type to transport a person while seated in a scooter.

**⚠ Warning :** Do not sit on your scooter while it is in a moving vehicle. Personal injury may result. Always make certain that your Luggie is properly secured when being transported. Failure to comply may result in personal injury and/or damage to your Scooter.

## ACCESSING YOUR SCOOTER

Getting on and off your scooter requires a good sense of balance. Please observe the following tips when getting on or off your scooter:

- Make certain your Luggie scooter is powered off.
- Ensure your Luggie is not in the freewheel mode (page 12), Freewheeling Your Luggie).
- Make certain the seat and handlebars are locked firmly into position.

The armrests can be lifted up to allow easier access. If your armrests are installed, make certain you do not attempt to drive with the armrests raised.

**⚠ Warning :** Position yourself as far back into the scooter seat as possible to prevent tipping and injury.

**⚠ Warning :** Avoid using the armrests for weight bearing purposes. Such use may cause the scooter to tip and cause personal injury and/or damage.

**⚠ Warning :** Avoid putting all of your weight onto the floorboard, such use may cause the scooter to tip and cause personal injury.

**⚠ Warning :** Do not overload your scooter at the rear when climbing an incline. Always lean forward to provide the best stability and prevent rearward tipping.

**⚠ Warning :** Any attempt to climb or descend an incline steeper than shown in the scooter specification at the rear of this manual may put your scooter in an unstable position and cause it to tip, resulting in personal injury. Never remove the anti-tipping wheels of your scooter. They are an important part of your scooters design. See also Incline.

## MODIFICATIONS

Luggie scooter has been designed to provide maximum mobility. A range of accessories are available from your Authorized Luggie Resellers to further customize your scooter needs. Under no circumstances should you modify, add, remove or disable any feature, part or function of your mobility scooter.

**⚠ Warning :** Failure to observe the above warning may result in personal injury and/or damage to you, your scooter and properties.

## INCLINES

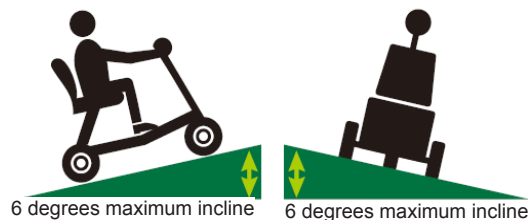

More and more modern buildings are designed with disability access in mind. Ramps have specified percentage of incline designed for easy and safe access. Some ramps may have turning switchbacks (180 degree turns) that require you to have good cornering skills on your scooter. Proceed with extreme caution as you approach the downgrade of a ramp or other incline. Always sit with your back on the back rest of your seat, brace your hands on the handlebars and position your feet on the floorboard of your scooter.

Take a wide arc with your Luggie around tight corners. Your rear wheels will follow preventing you from cutting the corner short and bumping or getting hung up on raised curbs. When descending an incline, keep your speed adjustment set to the slowest speed to ensure a safely controlled descent. Always drive down an incline facing forward only. If your scooter descent is quicker than you anticipated, allow the scooter to completely stop, then progress at a slower speed setting.

**⚠ Warning :** Never drive down an incline at full speed. When climbing an incline, try to keep your scooter moving. If you must stop, start up again slowly and then accelerate smoothly with caution. Avoid sudden stops and starts. Lean forward towards your handlebars to increase stability and prevent rear tipping when moving up the incline.



## STAIRS AND ESCALATORS

**Warning :** Luggie scooter is not designed to travel up or down stairs or escalators. Always use an elevator. Failure to observe this warning may result in injury to yourself and others and damage your scooter.

## DISPOSAL OF ELECTRO-MOBILE SCOOTER

In time when your scooter becomes unusable it must be disposed of in accordance with the laws implemented at that time. For further information regarding the recycling arrangements for this type of vehicle and its batteries, contact your local authority or government department.

# SAFETY WARNING & INSTRUCTION LABELS

The following labels are positioned on your Luggie. These labels communicate important warnings or instructions regarding the safe operation of you scooter. Please familiarize yourself with their location.



Located on front of the Scooter's chassis

**Caution: DO NOT** touch the locking of pull lever when people are sitting on the chair.

Located on top of locking of pull lever

PLO1-0406

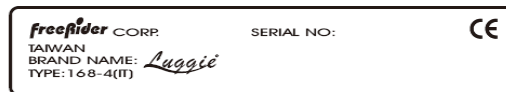

Data serial plate located on front wheel cross member



Located on middle of chassis



Located on middle of folding chassis



Located on middle of handlebars tiller



PLO1-0417

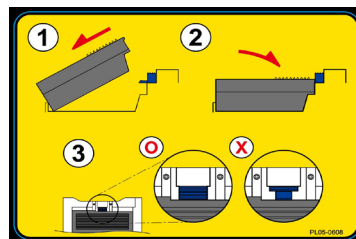

Located at the left hand rear cover of scooter



## LEARNING TO GET AROUND

**⚠ Warning :** If you are not an accomplished outdoors mobility scooter driver, we strongly recommend that you first practice in an open area, free from traffic and preferably with an attendant who can assist you. When ready, proceed to power on the Luggie. The battery indicator gauge needle will move to the amount of charge left on your battery and the status light on the power switch will illuminate as a solid. Gently press the right wig wag lever (FIG 11, page 11) to move forward. To stop, simply release the wig-wag lever to trigger the brakes.

**⚠ Warning :** When powering on the scooter, do not accidentally depress the wig-wag levers on your Luggie. The above action will result in your scooter going into fault mode. To clear the fault, power off before powering back on.

**⚠ Warning :** If your Luggie has been adapted for left hand user, forward and reverse operations will be reversed. For instance, when you press the left wig-wag lever the scooter will move forward and the right wig-wag lever will drive the scooter in reverse.

### LEARNING TO GET AROUND TIGHT SPACES

If you must steer in a tight spot, such as through a doorway or when turning around, stop, turn the handlebars to where you want to go, and then apply the power gently. This will make the Luggie turn sharply yet move gently, with complete stability. Practice in an open area, until you are proficient. Driving in reverse will require more attention (FIG 11, page 11).

**Remember:** When driving in reverse, you have to steer in the opposite direction to the way you want to go. Practice in open space as required. Please note, reverse speed is set to half the forward speed for your safety.

**Remember:** If trying to make a tight turn, turn your steering column or tiller before applying power. Steer wide of all corners and obstacles. Please move slowly with care.

**⚠ Warning :** Do not power off your scooter while it is in motion. Failure to observe this warning may irreparably damage the main electronic speed control unit or transmission. Always power off when your scooter is stationary.

### GETTING THROUGH DOORWAYS

When you start using your Luggie, you will meet some obstacles that will require some practice for smooth driving experience. Here are some common problems, with tips to help you master them quickly. You will soon be in control through doorways and travel up and down ramps with surprising ease by following the tips suggested below.

Approach an unfamiliar doorway slowly. Size it up. Does the door have a knob or push bar? Does it open toward you or away from you? Think in terms of using the power of the Luggie to do the work for you! You need not strain. Hold the door knob or bar in one hand and apply power with the other hand. (Remember that you can

drive forwards by using your left finger to move the wig-wag lever towards you.) If the door is self-closing, you can go through, allowing the door to close behind you, if you go quickly enough. If not, just stop when you have clear of the door before pushing it close.

If, however, the door opens toward you, hold the knob or bar with one hand and gently let the reverse power do the work. When the door is open wide enough, move forward quickly, leaving the hand on the door to keep it free of the scooter and letting go as you pass the doorway.

If you're not able to move, your rear wheel is probably caught. Reverse and try again. Take your time. Relax. Enjoy yourself. The techniques described above will take some practice. Practice makes perfect. Remember, your Luggie can do the work without wearing you out!

### MOVING ON AN INCLINE

More and more buildings have ramps for wheelchair access. Some have a change of direction in the middle. Good cornering skills are required. First, make a wide turn with your front wheel around tight corners, so that your back wheels follow a wide arc to stay clear of the corner. If you stop while going uphill, the automatic parking brake will keep you safe. To start again, slowly depress the forward direction wig-wag lever. The parking brake will release and you will start to move again.

**Remember:** When you approach an incline, it is best to lean forward, (Fig14, Fig15, page 20). This moves the center of gravity of your Luggie towards the front of the scooter for improved stability. When going down an incline, keep your speed slow. This will keep you in a safely controlled descent. It is recommended for you to lean backwards as you descend. If you wish to stop completely, release the wig-wag lever, and you will come to a gentle stop. For your safety, always avoid sudden stops and starts.

**Warning :** Do not exceed the incline guidelines or any other specifications presented in this manual.

### CONTROL TRAVEL OVER STATIONARY OBSTACLES

Stationary obstacles (steps, curbs, etc.) must be avoided where possible. Luggie has a ground clearance of 2.5 inches (6.4 cm). Proceed with extreme caution when driving near raised surfaces, unprotected ledges and/or drop-offs such as curbs, porches, stairs etc. should be avoided.

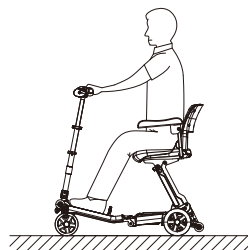

FIG 14

FIGURE14: Normal driving position

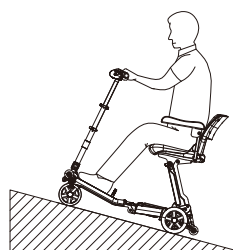

FIG 15

FIGURE15: Increased stability driving position

Most new pavements have wheelchair access ramps at intersections. Plan your route where possible to avoid poor and uneven surfaces. Do not attempt to ride up or down curbs as you will damage the integrity of your scooter.

### **MOVING OVER GRASS & GRAVEL**

Care must be taken when attempting to drive over soft surfaces such as those found in parks, etc. These surfaces may look level; but, hidden dangers on these surfaces may make your Luggie become unstable. Avoid unkempt and wet grass, loose deep gravel and/or sand. Do not exceed the capabilities of your scooter. Always have an attendant to assist you in circumstances where you are not certain of the safe travel conditions or the terrain. Always anticipate and think safety first.

**△ Caution :** When climbing inclines, the maximum safe gradient limit is 6 degrees. To ensure your safety and the stability of the scooter, always have the anti-tipping wheels fitted to your scooter (FIG 16) when climbing inclines or maneuvering obstacles. Always avoid turning on slopes or climbing curbs.



**FIG 16**

**△ Caution :** Always make certain that your Luggie is in full working order before attempting to drive.

**△ Caution :** Always lean forward when ascending an incline and backwards when descending an incline to ensure stability as you drive.

**△ Caution :** Never attempt to drive beyond the design capability of your Luggie. Observe weather conditions at all time. Tires can slip on wet or icy surfaces.

**△ Caution :** Do not drive through deep water or leave your Luggie exposed to heavy rain especially during or after wet weather conditions.

**△ Caution :** Do not attempt to turn when navigating up an incline. It is advised that you only turn when all wheels of your scooter are fully on or off the incline. Failure to observe this caution may result in the scooter toppling over.

**Please note:** The stability of your scooter is dependent on a number of factors which you should consider before attempting to climb an incline or other obstacles: (a) your height; (b) the height of your seat; (c) your weight and (d) the angle of the incline you are attempting to climb. All of these factors can affect the stability of your Luggie scooter. If you are unsure of your ability to navigate through an obstacle, incline or a surface, try another route. Always think 'safety first'.

***Please take care and be safe.***



## TRANSPORTING YOUR LUGGIE

Whether it is for a holiday, a day out to visit family and friends, or a trip to go shopping, your Luggie can be taken along. Depending on the size or model of your car, you will be able to load your Luggie in one of the following methods.

1. Load your Luggie with the aid of a car hoist. Your dealer will be able to advise on suitable equipment.
2. With the floor board of the Luggie secured in place, lower the seat and tug on the front bumper to transport it into the trunk, bed of your SUV or in the passenger side of your car with the seat belt securely around the scooter as pictured.
3. With the seat lowered and the scooter completely folded, lift Luggie into the trunk or bed of your sport utility vehicle (SUV) for ease of transport.(see FIG 19,20, 21).



FIG 17



FIG 18



FIG 19



FIG 20



FIG 21

Follow these simple instructions for folding your scooter. This procedure can be carried out quickly and without the use of tools. Refer to Operating your Luggie on page 8. It is recommended that you transport the battery in the box that shipped with your Luggie and lay the battery on level surface.

**⚠ Warning :** Do not place metal objects over open battery contacts. This may cause the battery to short circuit.

**⚠ Caution :** Protect clothing when lifting your Luggie. Some components may have lubricating fluids on their surfaces. Work out the best position to stow the components of your scooter. Your Luggie will increase the load in your car, please remember this and adjust your driving to suit this condition.

**Note:** When using access ramps to load your Luggie into a car, always keep your body clear of your scooter to prevent injury. Never ride your scooter when loading it into a vehicle, failure to observe this warning could put you into a dangerous situation. Always make certain your scooter and any ancillary parts are correctly tied down in the transport vehicle to prevent movement during acceleration, deceleration and braking. Most modern cars have anchor points on the bed of your car/trunk/SUV to secure your scooter and accessories.



**Remember:** You have increased the load in your car, please take account of this and modify your driving accordingly.

**Warning :** Always make certain that your scooter is stored in the transport vehicle with the magnetic brake release system in the disengaged (brakes locked) position.

## BATTERY & BATTERY CHARGING

Your Luggie has a lot of power. Keeping Luggie working to its maximum potential means that its battery must be maintained at full potential. Nightly recharging, after use, will help giving the battery a longer life and will ensure your Luggie is always ready to go when you are.



**FIG 22**



**FIG 23**

### BATTERY PACK

Your Luggie scooter is shipped with a lithium battery, designed specifically for the Luggie. Follow the steps outlined below:

1. Position battery pack into the scooter battery compartment under the seat as outlined in the Quick Start Guide.
2. Switch on your scooter. The battery meter will now move to show the state of charge in the battery. If the needle of your battery meter is in the green zone, your scooter is ready to drive.

**Warning :** Do not attempt to open the covering of the battery. Failure to observe this warning will invalidate your battery warranty.

For air travel, please consult your carrier prior to departure. They will need advance warning that you wish them to carry the lithium battery. Please note that each carrier reserves the right not to carry what may be termed Hazardous cargo. FreeRider cannot be held responsible for their final decision.

### BATTERY CHARGER

The battery charger is designed especially for your Luggie (FIG 23). It may not be suitable for any other powered mobility product. Only use the chargers shipped with your Luggie scooter. The use of other chargers may permanently damage your battery and would invalidate the warranty.

## SAFE & LASTING BATTERY

1. For longest battery life, your battery should be re-charged when the battery meter indicator is in the red region or after use whenever possible.
2. If your Luggie battery will not be used for an extended period, fully charge the battery and disengage from the battery compartment of the Luggie before storage. Battery charge will gradually deplete with time. Please do a refresh charge every month when the battery has been stored for an extended period of time.  
(Remember: Keeping your battery charged will help extend the life of your battery and ensure that the Luggie is ready to go when you are.)

To charge your batteries follow these simple steps:

1. Switch off your Luggie.
2. Your charger has two leads exiting from it. Plug the 3-prong plug to charging socket located on the rear chassis of your scooter and the second lead to the charger unit before plugging it into the wall socket.

**Note:** If you need to use an extension cord for your main electric supply, make certain that it is safe and suitable for the charge current.

**Note:** Your Luggie will not drive if the charger is connected.

## LUGGIE CHARGER STATUS LIGHT INDICATOR

Orange: charging

Solid Green: charging complete.

## GENERAL

Depending on the depth of discharge, the minimum time to recharge serviceable batteries fully will vary from 1 hour up to 2 hours. Please note that recharge time will vary between the minimum and maximum times indicated due to the varying states of battery use. Please be patient.

## TROUBLE SHOOTING

1. If the green indicator is off, check the AC input. If the AC input works normally, the battery charger may be defective.
2. If the green indicator is working normally but the charging indicator (orange) is off, the polarity connection may be reversed. The output connection may be short or open.
3. If the charging indicator (orange) is still off when charging, the battery charger may be defective.
4. If the charging indicator (orange) does not turn green (charged state), the battery is not being charged normally. Please stop charging and have the battery repaired or checked by an Authorized Luggie Service Center.
5. If the charging indicator goes from orange to green (fully charged state) immediately, the battery may be fully charged.
6. If the battery does not charge, the battery may be defective. Have it checked by an Authorized Luggie Service Center.

## ADVISORY NOTES

1. Disconnect your plug from the wall socket before removing the 3-pin charge plug from the charge socket of your Luggie.
2. The Luggie charger is for indoor use only. Do not expose it to rain or moisture.
3. Do not smoke or expose your Luggie near open flame while the battery is being charged.

4. Do not use an extension cord to connect the charger onto the charging unit of your Luggie unless absolutely necessary. Use of an improper extension lead could result in fire and/or electric shock.
5. Do not use the charger if it has received a sharp blow, been dropped or otherwise misused in anyway.
6. Do not dismantle the charger, poke or drop objects through the slots in the charger case.
7. Do not unplug or interrupt the recharge cycle until the charging cycle has been completed. Failure to observe this instruction can damage the integrity of the battery.
8. There is a drive inhibit function on your scooter. The scooter cannot be driven when the charger is plugged into your Luggie.
9. Avoid exposure to heat when charging your battery.

### **YOUR GUIDE TO SAFE AND LASTING BATTERY**

1. For longest life of your battery, your battery should be recharged after use, preferably overnight.
2. When storing your Luggie and battery for an extended period, fully charge your battery and remove the battery from the leads on your Luggie scooter. The battery should never be stored fully discharged. Fully discharging the battery pack before extended storage will put your battery in a “sleep mode” which could render it un-chargeable when you are ready to use your scooter.
3. If your Luggie has been stored for some time, always recharge your battery before use.
4. Every six months, check the connection on the battery pack. Make sure the connection area is clean.
5. Your battery carries a limited manufacturer warranty which is subject to a stringent wear and tear clause. Any gradual deterioration in performance is normally associated with fair wear and tear. Misuse or accidental damage is not covered by the manufacturer's warranty.

### **CHARGING YOUR BATTERY AWAY FROM YOUR SCOOTER**

In circumstances when your scooter is stowed in your car, your battery can be recharged away from your scooter with the optional Luggie home docking station. Simply connect the 3-pin plug on your charger to the home docking station before connecting it to the wall socket. Insert your Luggie battery onto the home docking station to start charging the battery away from your scooter.



## **FREQUENTLY ASKED QUESTIONS**

### **Q: How do I turn on Luggie scooter?**

**A:** Locate the on/off switch below the handlebar on the right side. If you do not see a solid red on the switch, check to make sure the battery has been properly installed. Refer to the owner's manual for diagnosis.

### **Q: What does the magnetic brake release do?**

**A:** In time of emergency or when your battery is out of power, disengaging the magnetic brake release will inhibit you from driving the scooter; but, it will allow your scooter to be pushed freely by an attendant.

**Q: Are there safety modes in place even when the magnetic brake release has been disengaged?**

**A:** Yes. If the attendant pushes the scooter too quickly while the magnetic brake release is disengaged, the scooter will brake or stop. If this happens, come to a complete stop to allow the safety mechanism to reset before starting again. If the attendant pushes slowly, the scooter will move easily without braking.

**Q: What if my Luggie doesn't start?**

**A:** (a) Check to see that the battery is installed properly in the battery compartment before turning on the power switch.  
(b) If the battery is installed properly, check the battery indicator to see if the battery is fully charged. If the indicator is in the red zone or if the power switch flashes once per second your battery is low in power. Please charge your battery.  
(c) If the power switch flashes 5 times per second and your battery indicator is in the green zone (charged state) make sure the magnetic brake release hasn't been disengaged. If the magnetic brake release is disengaged, turn off the power switch, engage the magnetic brake release then turn on the power switch before driving.

**Q: How do I move forward, reverse and stop on the Luggie scooter?**

**A:** Gripping the right wig-wag lever let you move forward on Luggie scooter. Gripping on the left wig-wag lever allows you to move in reverse. To stop, simply let go of the wig-wag lever.

**Q: Am I able to adjust the speed of my Luggie scooter?**

**A:** You can adjust the speed of your Luggie by adjusting the speed control dial located on the left of the top console. When the dial is adjusted to the turtle mode, the scooter is at its slowest. As you adjust the dial toward the rabbit icon on the speed control dial, the speed of the Luggie will increase to the top speed of 4 MPH.

**Q: When should I charge my battery?**

**A:** Charge your battery when the battery indicator is in the red region on the battery indicator on the top console of your scooter.

**Q: How long will it take to fully charge the battery?**

**A:** The time required to fully charge your battery will depend on the depth of discharge on the battery. The minimum time taken to recharge the battery fully will vary between 4 to 6 hours.

**Q: What do I do if I want to store my Luggie and battery for an extended period of time?**

**A:** When storing your Luggie and battery for an extended period of time, fully charge your battery and remove the battery from the connector of the scooter. The battery should never be stored fully discharged. Fully discharging you battery pack and storing your scooter will put your battery in a "sleep mode". Your battery may not be chargeable if left in the "sleep mode" for an extended period.

**Q: How should I fold the Luggie to check it for air travel?**

**A:** The best way to fold the Luggie and check it for air travel is to retract the tiller and fold both the tiller down to the base of the scooter along with the seat. By making the scooter flat (folding down both the tiller & the seat ) like FIG 2, page 8, it is easier for airline crew to handle and transport the scooter without damaging the scooter.

**Q: How do I remove the battery from the battery compartment?**

**A:** To remove the battery from its compartment, press the battery release button all the way in, while pulling on the back edge of the battery to release the battery from the locked position.

**Q: How long will my lithium battery last?**

**A:** The life of your lithium battery will depend on use and care. Like any consumable product, the battery will deteriorate in performance and reduce in range with time and use. Battery tend to deteriorate in performance and reduce in range when left in a discharged state, left in cold conditions for extended periods or worn due to heavy use.

**Q: Where can I drive Luggie?**

**A:** The Luggie was designed to provide optimum stability under normal driving conditions for indoor use on dry, level surfaces. We realize that there will be times when you will encounter other surfaces. Please take caution when driving in any conditions. Luggie is not recommended for uneven terrain, rain, snow, steep inclines, sand gravel or uneven surfaces.

**Q: How do I unfold my Luggie scooter?**

**A:** Refer to the Quick Start Guide provided in your packaging or the owner's manual on unfolding your new scooter.

**Q: How do I adjust the angle of my tiller?**

**A:** Lift the trigger handle out to bring the tiller toward or away.

**Q: What should I do if my battery doesn't charge?**

**A:** Call the customer service department to trouble shoot. DO NOT REMOVE THE SEAL FROM THE BATTERY. YOUR BATTERY WARRANTY WILL BE VOID IF THE SEAL IS BROKEN. If the battery is faulty and still under warranty, request a RMA (Return Merchandise Authorization) number from your Authorized Luggie Dealer before shipping back the battery for replacement. If the battery is no longer under warranty, properly dispose of the old faulty battery and purchase a new Luggie battery from an authorized reseller.

**Q: Who do I contact if I need replacement parts for my Luggie scooter?**

**A:** Contact your authorized Luggie reseller for replacement parts on your Luggie scooter.

**Q: How do I ensure my seat is locked in position?**

**A:** Check to see that the seat lock indicator is red on both the right and left side to ensure your seat is locked in place. Refer to the Quick Start Guide to locate the seat lock indicator.



**Q: Where can I purchase accessories and/or replacement parts for the Luggie scooter?**

**A:** You can purchase accessories and Luggie parts from Luggie Authorized Dealers .

**Q: What is the return policy on my Luggie scooter?**

**A:** Refer to the warranty sheet shipped with your scooter.

**Q: Where do I find the serial number for my Luggie scooter?**

**A:** The serial number for your scooter can be found on the underside of the scooter. With the scooter in the unfolded position and the Luggie chassis hooks locked, lift up the front bumper and set the scooter upright. The serial number will be on the left inside frame of your scooter.

**Q: How do I fold my Luggie to put in the Luggie suitcase?**

**A:** (a) Compress the tiers of the tiller completely.  
(b) Lower the tiller by lifting the trigger to lower the tiller.  
(c) Lock the tiller in the tiller locking clamp.  
(d) Unhook the chassis hook.  
(e) Bring down the chair by simultaneously squeezing on the seat lock handle as you guide down your seat.  
(f) Pull up on the base of the chair until the front chassis locks with the back chassis.

**Q: Does the Luggie go to sleep when it is idle for a long period of time?**

**A:** Yes, the Luggie will go to sleep when idle for over 15 minutes.

**Q: How do I wake the Luggie once it is in sleep mode?**

**A:** There are 2 ways to wake the Luggie in sleep mode. One way to wake the Luggie is to toggle the wig-wag a couple of times to wake the scooter. The recommended way to wake the Luggie is to power off the scooter before powering it back on.

**Q: Will my battery deplete in power when it is in sleep mode?**

**A:** Yes, your Luggie battery will deplete in power even in sleep mode. If your scooter is idle for an extended period of time, it is recommended that you power off the scooter completely to conserve battery power.

**Q: What's the recommended way to adjust the angle of the tiller?**

**A:** It is recommended that you lift the trigger upward completely before adjusting the angle of the tiller so as not to unnecessarily wear the mechanism.

**Q: When should I charge my Luggie battery?**

**A:** It is recommended that you charge your battery when the battery indicator is in the red zone. This will prevent your Luggie scooter from stalling or coming to a complete stop when you are out and about.

**Q: Do I need to remove the battery when I travel via air?**

**A:** According to the International Air Transport Association (IATA) the removal of the lithium battery is required before your Luggie scooter can be checked without restrictions. According to IATA each passenger is allowed the capacity of one Luggie lithium battery. If you would like to travel with additional batteries, please ask your travel companion to carry it for you or check with your airline of travel for additional details.

**Note:** It is recommended that you check with your airline of travel prior to traveling in regard to checking your Luggie scooter. Please be advised that different airlines may handle the situation differently.

**How can I ensure maximum battery life?**

Simply put, a fully charged battery is a happy battery! A fully charged battery will provide reliable performance and extended battery life, so keep your battery fully charged whenever possible. Extra care must be taken when handling batteries, if you decide to fold your vehicle for transportation etc. Dropped battery, even from a very small height, can lead to damage of the internal components, causing premature battery failure. **Do not open the battery casing, doing so will void the warranty.**

**Disposal**

**⚠ Caution :** Used batteries must be disposed of properly. Please contact your local electronic waste facility to dispose of used batteries properly.

**BATTERY WARRANTY**

The battery shipped with your Luggie has a limited warranty to be free of material defect or workmanship for a period for 12 months. Any battery faults due to a defect in manufacture or materials will be obvious within a few weeks of use. The condition of your battery will be dependent on the actual use of the scooter and how often the battery is cycled ie discharged and charged. Gradual deterioration in performance and reduction in range is normal and associated with fair wear and tear, misuse or accidental damage. Under these circumstances, the warranty will not apply. Some users due to their hectic lifestyle, weight or operating conditions, may wear their battery out during the original battery manufacturer's guarantee period due to extensive use of their scooter. The battery has a defined number of discharge cycles it can make. The more times you use your scooter the more cycles your battery will make; the shorter their life span.

**Remember:** The longevity of your battery will be dependent on your care in breaking in the battery.

Best practice for new battery:

1. Fully charge new battery prior to your initial use. This will bring your battery up to about 88% performance.
2. Ride your vehicle around the house or garden. Do not venture too far away until you become accustomed to the controls and feel of the scooter. This will gently break in your battery.
3. Give your battery another full charge and run the scooter again. The battery will now perform to over 90% of their full potential.

4. After ten to fifteen charging cycles, the battery will top off at 100% charge and last for an extended period. It is important that you follow the steps outlined above for the longevity of your battery.

### How can I get the maximum operating time per charge?

Rarely do we have the ideal driving situation (smooth, flat, hard terrain with no wind or curves and warm temperatures). More often, we are presented with hills, uneven and loosely packed surfaces, curves, wind, cold and heavy loads. Conditions described above will affect the distance or running time of your battery charge.

Here are a few suggestions for obtaining the maximum range per charge:

1. Always charge your battery fully prior to your trip.
2. Plan your trip in advance to avoid inclines, curbs and soft surfaces.
3. Limit your baggage weight to essential items.
4. Try to maintain an even speed to avoid stop and start driving.
5. Ensure recommended routine servicing of the vehicle's components.

**⚠ Warning :** When working on or disposing of your batteries;

1. **DO NOT** allow metal objects to short out the terminals of your battery. This could cause the battery to explode and cause injuries..
2. **DO NOT** allow your battery to freeze. If frozen allow it to naturally thaw out before charging, failure to observe this warning may damage the battery.
3. If you need to replace your battery, contact your Authorized Luggie Reseller. Original Luggie parts will give you the best performance.
4. Always handle battery with care.
5. Dispose of worn out battery by contacting your local waste/electronic waste disposal authority.

## LITHIUM BATTERY INSTALLATION



**FIG 24**



**FIG 25**

Slide lithium battery with Luggie logo against the edge of the battery compartment under the seat before snapping it into place to lock.(FIG 24 & 25)



**FIG 26**

Your Luggie fully folded.(Fig 26)



Luggie



Luggie Elite

**FIG 27**

How to read the battery indicator meter  
Three sections on your battery indicator meter (Fig 27)

1. **Red** : Depleted battery voltage.
2. **LightGreen** : Low voltage.
3. **Green** : Fully charged.



## CARE & MAINTENANCE

Your Luggie like any other electro-mechanical scooter will benefit from regular servicing by your Authorized Luggie Dealer. You too, can help keep your Luggie in tip top condition by following the simple guidelines outlined below.

**Note** : Only competent people should carry out service work.

### SEAT UPHOLSTERY

A damp cloth and a little soapy water will keep your seat, backrest and armrests looking new. Do not use abrasive cleaners as this will damage the coating on the upholstery. The coating on the upholstery will degrade over time with use due from natural oils in your hair and skin, UV light, general use and handling of your scooter.

### BODY WORK

The painted body work on your Luggie scooter can be lightly washed with clean soapy water. Do not use abrasive cleaners or strong detergents. The use of abrasive or strong detergents may fade the color. Use cleaning solutions safe for automobiles. Salt contact (ocean air) is very corrosive to metal parts on your Luggie scooter.

**△ Caution** : Do not hose down your Luggie with a power washer. Water could be forced into the electronics and cause permanent damage to your scooter.

Always use a soft cloth to clean your Luggie. Auto polish may also be used to keep the paint work and bright chrome parts in pristine condition. The metal frame work of your Luggie should be cleaned once a year and any paint work damaged should be treated to prevent further attack from the elements. Do not store your Luggie in damp conditions. This may affect the electronics if left for very extended period of time. Moisture, if left unattended can cause deterioration to the metal frame.

## ELECTRONICS

Servicing of the drive electronics and charger should only be carried out by your Authorized Luggie Service Dealer. These units are sealed and should not be opened. **BROKEN SEALS WILL INVALIDATE YOUR WARRANTY.** Below are some pointers to keep in mind.

1. **DO NOT** operate your Luggie in exceptional weather conditions i.e. very heavy rain.
2. Cover your scooter if it is left unattended and outside for a long period of time.
3. **DO NOT** drive your Luggie through deep water. This could damage the electronic speed controller. Sea and road salts are very corrosive and should be avoided if possible.

## DRIVE TRANSMISSION LUBRICATION

The Luggie is fully lubricated on delivery. You will not need to fill transmission fluid on your scooter. Note: Your Luggie transmission is filled with a special lubricant. Do not attempt to force grease into the transmission as this will contaminate the original lubrication and will invalidate your warranty.

**⚠ Caution :** When lifting the transmission, keep well away from clothing. It is normal to find a light film of lubrication around this part.

## MOTOR BRAKES

**Safety Note:** For your own safety, we recommend that you check the function of your Luggie brakes prior to any journey. If the motor brake is functioning correctly and the drive is engaged, you will not be able to push your scooter when the scooter is powered on or off without the use of the wig wag levers. Refer to the Freewheeling Your Luggie on page 12 for additional details.

**⚠ Warning :** Letting go of the wig wag lever while driving will reduce the speed of your Luggie very quickly. If you notice a change in the normal slowing/braking condition of your scooter, or if your Luggie does not slow down quickly, please do not use your scooter. Contact your Authorized Luggie Dealer.

## TIRES

Check the condition of your tires regularly. Look for signs of wear, cuts and foreign objects lodged in the tread of your Luggie tires (FIG 28).



**FIG 28**



## TIRE SERVICING REAR WHEELS

To remove a rear wheel from your Luggie follow the instructions below (ONLY COMPETENT PEOPLE SHOULD CARRY OUT THESE PROCEDURES).

- Power off your Luggie.
- Using a suitable body stand, lift the side of the vehicle you wish to service off the ground. Place the stand under the chassis. Care must be taken when lifting heavy loads. You may need a friend to help you. Please be safe. Do not lift the scooter by the plastic body work.
- With the aid of a 13mm spanner (not supplied), remove the center hub nut and washer.
- Slide the wheel from the mounting axle. Rear wheels are fitted to the drive axle via a hub which is located onto a key. These wheels fit tight onto the axle and may need some pressure on the wheel hub to release them from the axles. Look for spacing washers and take care not to misplace the drive key which fits between the wheel hub and the axle shaft.
- To reassemble the wheel simply follow the above procedure in reverse order noting the following points:
- Make certain that you replace any spacing washers and keys in the order that they were moved.
- Locking Screws: The special 'locking' center hub screws may lose its effectiveness when it has been removed over a number of times. New screws should be used each time the wheel is removed. Contact your Authorized Luggie Reseller to purchase parts or have the tires replaced.

## TIRE SERVICING FRONT WHEELS

Your Luggie is fitted with solid tires which require minimum maintenance. Tires should be changed out when the tread have been worn out or cracked due to weather. Remove the wheel from the fork or turning axle shaft with the aid of 19mm and 21mm spanners (tools are not included). The front wheel has two bearings which may have various spacing washers between the forks. Please note the order of these washers. Remove the tire from the wheel by following steps above for rear wheels, using a 10mm spanner and 4mm hex key. Reassembly in the reverse procedure making certain that all washers supplied are replaced in the correct order removed.

## BATTERY

Keep your battery well charged (see Battery Charging section of this manual). Keep battery clean and store in dry frost-proof location. Your Luggie Dealer will be able to test your battery for its condition.

**Note :** Service charge may apply for this service.

**IMPORTANT:** It is not possible to predict the life expectancy of your battery. This is mainly due to the different workloads a battery can be subjected to during your day to day use. The life of your battery will be dependent on the following: motor loads, general service factors, care and maintenance working conditions, periods of nonuse and abuse etc. When you ready to replace your Luggie battery, always order the battery made for your specific scooter.

**⚠ Warning :** Contact your electronic waste disposal facility to properly dispose your Luggie battery.

**Note:** The charger supplied with your Luggie scooter is specifically designed for Luggie battery and may not work correctly with other brand of battery. (Refer to Batteries and Battery Charging section of this manual for additional details.)

## LUBRICATION

The Luggie is designed with low maintenance in mind. Wheel and steering bearings are sealed for life. The following are suggested service intervals for your Luggie scooter.

**⚠ Caution :** Only drive your Luggie scooter if it is in full working order.

## RECOMMENDED SERVICE INTERVALS

### DAILY CHECKS

- Operation of motor brakes
- Operation of driving brake
- Operation of seat lock
- Tire condition
- Battery capacity

### WEEKLY CHECKS

- Chassis locking mechanism
- Armrest adjustment knobs
- Allow battery charger to go through a full recharge cycle. Wait until the green light illuminates.
- Clean paintwork with auto shampoo. DO NOT use harsh abrasives or power washer.

### SIX MONTHS CHECKS

- Tire wear, replace as necessary.
- All fasteners and fittings for sound function.
- Tension of handle bar lock and hinge bolt.
- Battery connections.
- Inspect all electrical plugs and sockets for damage, good contact and fit.

### ANNUALLY CHECKS

- Front wheel bearings for wear.
- Handlebar bearings
- Chassis for sound welds
- Rear drive wheel hub keys
- All wheel bolts
- Drive axle securing bolts
- Motor mounting bolts
- Magnetic motor brake disc and function
- Main wiring loom for damage

- All steering components
- Clean chassis and repaint any exposed parts.
- Replace any damaged axle seals.
- Cycle charge for full operation function.
- Cycle test batteries for operating capacity. (Ask your Authorized Luggie Dealer for details.)

**Note:** Annual inspection will include weekly, semi-annual and annual checks listed above.

### LUBRICATION

Use a general purpose noncorrosive lubricating fluid (i.e. WD-40) on moving parts. All wheel bearings are factory sealed and should not normally need lubricating. Handlebar bearings should be lubricated with a general purpose bearing grease. Your drive axle is factory filled with a special lubricant and will not normally need replacing.

**△ Caution :** Do not mix other lubricants with this factory fitted drive axle lubricant. Failure to observe this caution will invalidate your warranty.

**Note:** Service interval recommendations are guidelines for proper care and maintenance of your scooter. More frequent use of your scooter may require more frequent adjustments to these suggested intervals listed above.



## BASIC FAULT FINDING

### **Q: What if my Luggie will not start?**

**A:** Check to see whether the power switch has been switched 'on'. If it is, the battery indicator meter will be operating. If the status light on your top console is flashing once per second, your battery is low in charge. Charge your battery.

### **Q: What if the status light on the power switch fail to operate when the switch is in the 'on' position?**

**A:** Make sure the charger is not plugged into the charge socket of your scooter. When your scooter being charged, you will not be able to drive.

### **Q: What if my Luggie stops for no apparent reason?**

**A:** Your battery may not be working properly. Contact your Authorized Luggie Reseller.

**Q: What if the battery indicator is operational but the status light flashes and the Luggie is inoperable?**

**A1:** Check the status fault codes (page 37-38) indicated by the LED on your power switch flashing.

**A2:** Check to make sure that the magnetic brake release is not disengaged. If the magnetic break release is disengaged, the status light on the power switch will flash five times.

**Q: What if my Luggie does not slow down or behave erratically?**

**A:** Switch off the power and contact your Authorized Luggie Dealer.

**⚠ Warning :** If you find for any reason your Luggie does not reduce speed when you let go of the wig wag lever (FIG 9, page 11), power off your Luggie. The parking brake will activate immediately and stop your scooter. Be aware that the scooter will stop very suddenly. Hold onto your handlebars and sit back in your seat.

**⚠ Warning :** The above operation should only be carried out in an emergency; continual use of this facility will damage the drive transmission and motor brake. Inform your Authorized Luggie Dealer before using your scooter again.

**⚠ Warning :** If you feel for any reason that your scooter is not driving correctly or making unusual noise, stop using the scooter and contact your Authorized Luggie Dealer.

## **SPEED CONTROL**

The speed controller system incorporates a sophisticated microprocessor which continually monitors the Luggie scooter's systems to ensure safe and reliable operation. Safety conditions monitored by the speed control are listed below:

- Speed control system integrity
- Internal voltages and circuits
- Motor voltages and circuits
- Freewheel speed limiting downhill
- Battery voltage

When the battery voltage is low, the 'status' indicator light situated on power switch will flash slowly as a warning for you to recharge your batteries. If the 'speed controller' detects a fault, the light will flash more rapidly, with the number of flashes indicating the nature of the fault. If your scooter is switch 'on' but not operated for a set period of time (15 minutes approximately) the speed controller system will automatically turn itself 'off' to conserve valuable battery energy. This fault can be cleared when you power off then power back on.

## **FAULT DIAGNOSIS**

Faults with the main speed controller are rare. Most faults on powered scooter are associated with wiring or bad connections due to poor maintenance or

incorrect installation of connectors when assembling the scooter after transporting the scooter. If your Luggie scooter fails to operate refer to the status fault codes on the following page for reference. If in doubt, consult the dealer from whom you purchased your Luggie scooter.

**DO NOT OPEN THE BATTERY HOUSING. BREAKING THE BATTERY SEAL VOIDS THE WARRANTY AUTOMATICALLY!**

### SPEED CONTROLLER SETTINGS

**⚠ Warning :** Performance adjustments should not be made to the wig wag levers which could compromise the integrity of the speed controls and put the operator in a serious danger. Performance adjustments should only be made by an Authorized Luggie technician fully trained and conversant with the programming and capabilities of the Luggie scooter.

**⚠ Warning :** Incorrect settings could cause injury to the scooter operator and/or to bystanders or damage to the scooter and/or surrounding property. If in doubt, consult your Authorized Luggie Dealer.

### STATUS FAULT CODES

| FLASH | Description            | Meaning   |
|-------|------------------------|---|
| 1     | Battery Low            | The battery is running low. Recharge the battery  |
| 2     | Low Battery Fault      | The battery has run out of charge. Recharge the battery.  |
| 3     | High Battery Fault     | Battery voltage is too high. This may occur if overcharged and/or traveling down a long slope. When traveling down a slope, reduce your speed to minimize the amount of regenerative charge. Check the battery and associated connections and wiring.     |
| 4     | Current Limit Time-out | The motor has been exceeding its maximum current rating for too long. This may be due to a faulty motor. Check the motor and associated connections and wiring. Turn the controller off. Let it stand for a few minutes before powering it back on again. |



| FLASH | Description         | Meaning  |
|-------|---------------------|--|
| 5     | Park Brake Fault    | Either a park brake release switch is active or the park brake is faulty. Check the park brake and associated connections and wiring. Ensure any associated switches are in their correct positions. |
| 6     | Throttle OONAPU     | The Throttle is out of neutral when turning the controller on. Ensure the throttle is in neutral when turning the controller on. The Throttle may require recalibration.                             |
| 7     | Speed Pot Fault     | The throttle, speed limit pot, SRW or their associated wiring may be faulty. Check the throttle and speed pot and associated connections and wiring. Check the wiring harness of the scooter.        |
| 8     | Motor Voltage Fault | The motor or its associated wiring is faulty. Check the motor and associated connections and wiring.   |
| 9     | Other error         | The controller may have an internal fault. Check all connections & wiring.   |
| 10    | Push/Rollaway Fault | The scooter has exceeded the push or roll away speed limits. Turn the controller off and then on again to clear the fault.   |



## TECHNICAL SPECIFICATION

| Model Number                | Luggie                   | Luggie Elite              |
|-----------------------------|--------------------------|---------------------------|
| Overall Length(Unfold)      | 98.2 cm / 38.65 inches   | 98.2 cm / 38.65 inches    |
| Overall length(Fold)        | 66 cm / 26 inches        | 66 cm / 26 inches         |
| Overall width               | 45.5 cm / 18 inches      | 45.5 cm / 18 inches       |
| Ground clearance            | 6.4 cm / 2.5 inches      | 6.4 cm / 2.5 inches       |
| Maximum load                | 114 kgs / 250 pounds     | 145 kgs / 320 pounds      |
| Range up to                 | 18 km / 11 miles(90kg)   | 11 km / 6.87 miles(146kg) |
| Total Weight(excl. battery) | 23.5 kgs / 51.7 pounds   | 23.5 kgs / 51.7 pounds    |
| Turning radius              | 103.75 cm / 40.85 inches | 103.75 cm / 40.85 inches  |
| Maximum speed               | 6 km / 4 mph             | 6 km / 4 mph              |
| Li-Ion Battery              | 8.5 Ah                   | 10.5 Ah                   |
| Seat Width                  | 36.8 cm / 14.5 inches    | 41.91 cm / 16.5 inches    |

## CLASSIFICATION

Type 'B' indoor / with some outdoor capabilities (EN12184:1999) Class 2 (Highway Regulations 1988).

Maximum safe climbing angle: 6 degrees with 250 lbs (114 kg) and Luggie Elite 320 lbs (145 kg) weight capacity.

**⚠ Warning :** The safe climbing angle is measured with the seat in the highest position, and a weight capacity of 250 lbs (114 kg) and Luggie Elite 320 lbs (145 kg). The motor on your scooter is powerful and may be able to climb a steeper incline than the maximum safe climbing angle. Exceeding the safe climbing angle may put you at risk of injury. On no account must you attempt to climb an incline of more than 6 degrees. This will exceed the rear stability of your scooter.

**Maximum speed:** up to 4 mph (6 km/h) [+/-10%] dependent on weight and manufacturing tolerances.

**Range:** Luggie range up to 11 miles (18 km) when loaded 198 lbs (90 kg) ,Luggie Elite range up to 6.87 miles (11 km) when loaded 320 lbs (146 kg) between charges under ideal conditions.

**Note:** Range varies with weight, terrain, temperature, battery condition etc. and is subject to manufacturing tolerances. Your battery will require a period of "breaking in" before they will reach their optimum capacity (up to 20 charge, discharge cycles can be expected) before full range is experienced. Refer to the battery charging section of this manual.

**Tire Size:** Front 6 inch, Rear 7 inch. PU solid

**Batteries:** Luggie: Li-Ion battery 8.5/AH, complies with UN38.3  
Luggie Elite: Li-Ion battery 10.5/AH, complies with UN38.3

**Charger:** AC input.100-240 volt, 50/60Hz,  
DC output 24 volt. 5 Amp for li-ion battery

**Conforms to:** EN60335-2-29 and EN12184  
EN12184:1999 (Clause 9.8)  
EN55022:2010, Class B  
EN60601-1-2:2007/ CISPR 11: 2009+A1: 2010  
IEC61000-4-2/ IEC61000-4-3  
FCC Part 15:2010, Subpart B, Class B

**Electrical System:** 24 volt DC

**Drive system:** Rear wheel, direct drive via sealed drive axle

**Motor:** 24 volt DC. Permanent magnet totally enclosed for outdoor use. Internal brushes. 3.0 Amp (no load)  
70 W / 4100 RPM (Luggie) ,120 W / 3600 RPM (Luggie Elite).

**Brake:** Automatic dynamic regenerating braking system with spring activated magnetic solenoid parking brake and freewheel facility.

**Tiller:** Adjustable locking for driving comfort.

**Speed Control:** Proportional state of the art design for safety and smooth operation incorporated with 'Fault' diagnosis.

**Seat:** Contoured adjustable seat with height adjustment. Armrest are optional with multiple width adjustments.

**Charger:** Located on the rear chassis cover. (Complies with EMC Directive 89/336/EEC and with Medical Devices Directives 93/42/EEC.)

## SIZE SPECIFICATION-LUGGIE

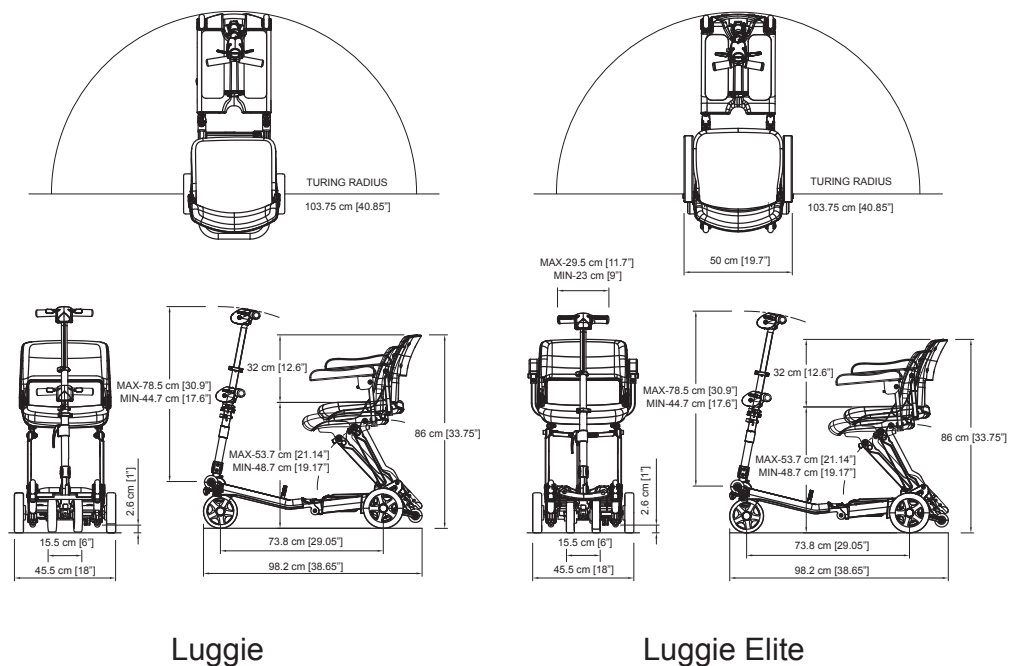

# LUGGIE ARMRESTS INSTALLATION GUIDE

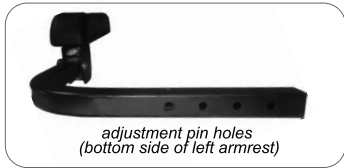
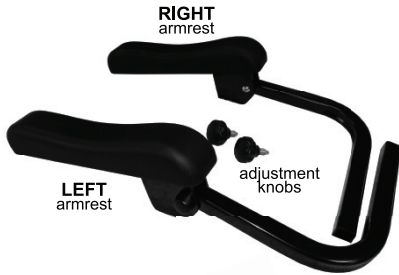

## Unpacking Armrests



Locate the **adjustment knobs** taped on either side of the armrests shipped with your order as pictured above.

## Installing Armrests

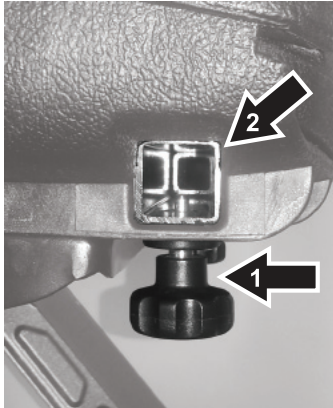

Locate the armrests and adjustment knobs included with your Luggie scooter order. The adjustment knobs can be found wrapped around each of the armrests.

- 1** Insert and screw the adjustment knobs on the back, bottom side of the seat assembly as pictured on the left. *(Note: The knobs do not need to be screwed in too tightly. These knobs are pull pin knobs that will allow you to adjust the width of your armrests.)*
- 2** Locate the left armrest, pull down on the adjustment knob while inserting the armrest into the opening as pictured on the left with the 4 pin holes on the bottom. Adjust the desired width of the armrest by pulling on the adjustment knobs to adjust the armrest to your desired width. Repeat the above steps to install the right armrest.



## ADVISORY SAFETY NOTICE

**⚠ Warning :** Radio wave sources may affect scooter control. Your powered scooter is designed to operate in appropriate environments; however, radio wave sources such as radio or TV broadcasting stations, amateur (ham) radio transmitters, two-way radios and cellular portable telephones can affect powered motorized scooters. The following warnings listed below should reduce the chance of unintended brake release or uncontrolled powered scooter movement.

- Refrain from using your cell phone, two way radio while driving your Luggie.
- Be aware of nearby transmitters such as radio or TV stations, and try to avoid coming into close contact with them.
- If unintended movement or brake release should occur, power off your Luggie as quickly as it is safe to do so.
- Be aware that adding accessories or components or modifying your Luggie scooter may make it more susceptible to interference from radio waves sources.

**Note:** There is no easy way to evaluate overall effect of the above to your Luggie scooter.

- Report all incidents of unintended movement or brake release to your Authorized Luggie Dealer, noting if there is a radio wave source nearby. Your Authorized Service Technician will then be able to diagnose your scooter to eliminate any possible scooter component failure.

Your Scooter has been tested to the following standards with reference to EN12184. Emissions EN55022(B), Immunity IEC61000-4-2, IEC61000-4-3, ESD IEC801-2.







**Note:** All figures, speeds, measurements and capacities shown in this manual are approximate and do not constitute specifications. Our policy is one of continual improvement. We reserve the right to alter, without notice, any weights, measurements or other technical data shown in this manual. If you require specific accurate data, please contact your Luggie Authorized Dealer.

***Enjoy your Luggie!***





## OPTIONAL ACCESSORIES

|   |   |  |
|---|---|--|
|    |    |    |
| Luggie Suitcase   | Storage bag   | Sling bag  |
|  |  |  |
| Adjustable armrest  | Home docking station  | Battery bag  |

Luggie is a one piece foldable mobility scooter with optional accessories for your convenience. For information regarding these optional accessories listed above, please contact your Authorized Luggie Dealer.

**⚠ Warning :** DO NOT over load accessories as this will affect the weight capacity of your scooter and decrease stability.



## WARRANTY TERMS

### WARRANTY TERMS

Please keep a note of your serial No.....  
(This is located on the front frame tube, under the front chassis cover).

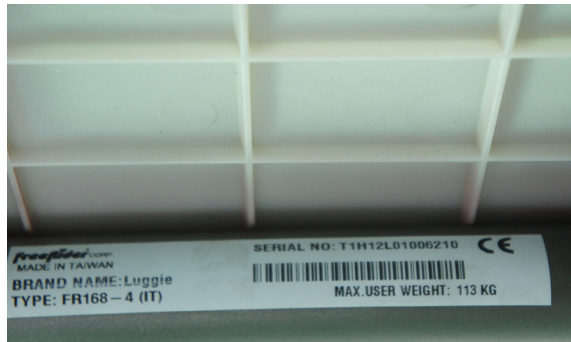

The frame of your scooter is warranted for 36 months, 12 months from the date of purchase against faults arising due to defects in manufacture or materials on electronic components. This warranty does not detract from, but is in addition to your legal rights. Parts replaced or repaired under the terms of this warranty will be covered for the balance of the period. This warranty applies only to parts supplied or approved by your Authorized Luggie Dealer. Refer to your warranty sheet for additional details. Due to the individual prescription nature of this product, this warranty is not transferable.

**Note:** Optional extended warranty insurance may be available from your Authorized Luggie Dealer.

**Exclusions:** This warranty does not extend to consumable items which may need replacing due to normal wear and tear, namely tires, punctures, lubrication, mats, oil seals, gaskets, screws, upholstery, motor brushes, fuses, batteries, handgrips etc. or to damage to the product caused by misuse, neglect or accident. This warranty does not apply if your Luggie shows signs of excessive wear and abuse, or has been modified without the authority of your Authorized Luggie Dealer.

The following items are not covered by your warranty:

1. Any noise or vibration, which does not affect the quality and function of the scooter.
2. Damage due to lack of maintenance or improper use or operation or storage.
3. Fees for the regular service inspection and maintenance.
4. Any fees incurred as a result of warranty repair, losses or compensation because of the inability to use the scooter (telephone use, shipping, car rental, travel fees etc.).

### **METAL WORK:**

Components, such as the frame work and bright metal parts require special attention and may deteriorate in certain conditions. Moisture and salt may corrode parts if left unattended. Auto cleaner polishes should be used to prevent long term damage. Failure to clean and protect these components may void your warranty.

### **PAINT WORK:**

This warranty does not cover deterioration of paint resulting from the lapse of time i.e. natural fading. It is the user's responsibility to clean and protect the painted surfaces.

### **SPEED CONTROLLER:**

Servicing of the speed controller or battery charger must only be carried out by your local Authorized Luggie Dealer. Any attempt to open or dismantle these items render the warranty void on that item immediately.

### **BATTERY:**

Batteries carry a limited 12 month warranty from the original manufacturer which is subject to a stringent wear and tear clause. Any battery faults due to a defect in the original manufacture will normally become obvious within the first two months of use. (See battery charging section of this manual for additional details.) Any gradual deterioration in the performance after this period is normal and associated with fair wear and tear, misuse or accidental damage and as such is not covered by the manufacturer's warranty. (Battery is warranted as a single part, only the failed part is replaceable.)

**⚠ Warning :** Do not attempt to open the battery. Breaking the battery seal will void the warranty on the battery.

### **SERVICE CHECKS:**

In line with all mobility vehicles, your Luggie will benefit from regular service inspections to keep it in pristine condition. The frequency of these service inspections will depend on the amount of use of your vehicle. We strongly recommend you contact your local Authorized Luggie Dealer to arrange for a service visit. (See Care & Maintenance Section of this manual). It is recommended that you fully service your Luggie at least every 12 months or more frequently depending on use. The warranty on your Luggie may not apply if routine maintenance is not carried out as defined in the Care and Maintenance section of the manual.

### **SERVICE CHECKS AND WARRANTY SERVICE:**

If your Luggie should need attention due to failure as defined under the warranty terms, please contact the dealer from whom you purchased your scooter. The Luggie shown and described in this manual may not be exactly identical in every detail as your own Luggie. However, all instructions are still entirely relevant, irrespective of detail differences. If you are unsure of any details mentioned in this manual, please consult your Authorized Luggie Dealer before driving your scooter. Warranty service checks must be performed by an Authorized Luggie Dealer and will generally be valid at the location where purchased. All transportation costs and shipping damage

incurred while submitting parts for repair or replacement are the responsibility of the purchaser.

**DISCLAIMER**

Luggie distributor/Freerider Corp. disclaims all responsibility for any personal injury or property damage which may occur as a result of improper or unsafe use of its products. Mechanical or electrical defects will be dealt with on a contingency liability basis. The part or parts will be replaced or repaired but no responsibility for damage or injury can be claimed. Guidelines in this manual are intended to assist you in the safe operation of your Luggie powered scooter. If you should have any questions about the correct operation of your scooter, please contact your Authorized Luggie Dealer. Consult your doctor and/or therapist if you are in doubt about your ability to operate your Luggie scooter.



This section is designed to assist you in keeping records of any service and repairs done to your Luggie scooter. Should you decide to sell or exchange your scooter in the future, this will prove most helpful to you. Your service agent will also benefit from a documented record. This manual should accompany the scooter when service or repair work is carried out. The service agent will complete this section and return the manual to you.

| DETAILS OF WORK CARRIED OUT | DEALER STAMP |          |
|-----------------------------|--------------|----------|
|                             |              |          |
|                             | DATE         | INITIALS |

| DETAILS OF WORK CARRIED OUT | DEALER STAMP |          |
|-----------------------------|--------------|----------|
|                             |              |          |
|                             | DATE         | INITIALS |

YOUR LOCAL DEALER

PHONE TODAY FOR FREE HOME DEMONSTRATION

**FreeRider**<sup>®</sup>

FREERIDER CORP

Head Quarter and Kaohsiung Facility:  
No.22,Bengong 5th Rd.,Gangshan Dist.,  
Kaohsiung City 820,Taiwan(R.O.C)  
Tel:886-7-6223093 Fax:886-7-6230373  
Email:sales @ freerider.com.tw  
<http://www.freerider.com.tw>  
<http://www.luggiescooter.com.tw>

2013.08.21 V3



PL90-0507