

# ***Compass Sport***<sup>TM</sup>



## **Owner's Manual**

### ***Compass Sport***<sup>TM</sup>

**Center-Wheel Drive Power Chair**

**GP605 CC/GP605 SS**



401 Bridge Street, Old Forge PA 18518  
Tel: (800) 624-6374 Fax: (800) 628-5165  
[www.goldentech.com](http://www.goldentech.com)

## FOR YOUR RECORDS

Please fill in your Compass Sport™ information below. This information will be useful in the event that you ever need to contact Golden Technologies, Inc. concerning your power chair.

Your Compass Sport™

Model \_\_\_\_\_ Serial Number \_\_\_\_\_

Date of Purchase \_\_\_\_\_ Body Color \_\_\_\_\_

Options \_\_\_\_\_

Your Golden Technologies, Inc. representative or provider

Name \_\_\_\_\_

Company \_\_\_\_\_

Address \_\_\_\_\_

Please remember to fill in and return your warranty registration card.

## ITEM CHECKLIST

Your Compass Sport™ shipped with the items listed below.

Before assembly or disposal of the packaging material, please make certain you have received all the items listed.

1. Base (Frame with power module, joystick cable, wheels, footplate, and shrouds)
2. Seat assembly with arms and accessory receiver
3. Safety Flag
4. Charger with storage pouch
5. Joystick
6. Seat Belt
7. Batteries (Two – U1) with battery cables included



## DISCLAIMER

We ask that you read this manual completely before operating your new *Compass Sport™*. Golden Technologies, Inc. is not and cannot be held responsible for any damage or injury incurred due to improper or unsafe use of the *Compass Sport™*, power chair. Golden Technologies, Inc. specifically disclaims responsibility for any bodily injury or property damage that may occur during any use that does not comply with applicable federal, state, or local laws or ordinances.

# CONTENTS

INTRODUCTION .....	4-5
SAFETY.....	6-9
EMI/RFI .....	10
SPECIFICATIONS.....	11
ASSEMBLY/DISASSEMBLY.....	12-16
COMFORT SETTINGS.....	17-20
OPERATION/DIAGNOSTICS .....	21-27
BATTERY CHARGING .....	28-29
CARE AND MAINTENANCE .....	30
WARRANTY.....	31-32
REGISTRATION CARD.....	33

# INTRODUCTION

Congratulations on the purchase of your new Compass Sport™ power chair. The Center-wheel drive Compass Sport™ combines cutting-edge technology with an attractive design that is also highly functional in today's world. We at Golden Technologies, Inc. know that you have chosen a power chair that will give you years of dependable operation and also will enhance the quality of your life by providing you with the mobility to experience an active daily lifestyle.

Even though your new Compass Sport™ is both user-friendly and designed for maximum maneuverability in even the tightest spaces, we ask that you please read, understand and follow all of the instructions and suggestions in this manual before you operate your Compass Sport™ for the first time. The safe use of your new power chair is very important to us.

If you feel that you do not understand the instructions and suggestions presented in this owner's manual, or if, for any reason, you do not feel capable of performing the activities necessary to assemble, disassemble, operate, or maintain your Compass Sport™ please contact your local Golden Technologies, Inc. representative or call Golden Technologies, Inc. Technical Support Services at (800) 624-6374.

Golden Technologies, Inc. cannot be held responsible for personal injury or property damage resulting from the unsafe or the improper use of any of our personal mobility products. Our Research and Development Department, our Quality Control Department, and our Engineering Department have used the latest product specifications and the latest product design information to produce your Compass Sport.

Golden Technologies, Inc. reserves the right to implement changes into our product lines when those changes become desirable or necessary. If changes are implemented into our product line, there may be minor differences between the product you purchased and the illustrations and instructions in this owner's manual.

Please fill out and mail the enclosed warranty registration card on page 33. We at Golden Technologies, Inc. would appreciate hearing about the dependability of your Compass Sport™ and about the convenience of mobility it has provided for you. We would also appreciate hearing about the service you received from your local Golden Technologies, Inc. representative.

Golden Technologies, Inc.  
401 Bridge Street  
Old Forge, PA 18518

Phone: (570) 451-7477  
Fax: (570) 451-7494  
Toll free: (800) 624-6374

Web Site: [www.goldentech.com](http://www.goldentech.com)

# INTRODUCTION

## ACCESSORIES for the *Compass Sport*

A variety of accessories are available for your Golden *Compass Sport*. Please contact your Authorized Golden Technologies Provider for more information or to order.

- Cane Holder Tube
- Oxygen Tank Holder
- Cup Holder
- Quad Cane Holder
- Walker Holder
- Crutch Holder
- Safety Flag
- Power Chair Cover
- Deluxe Pack N' Go
- Seat Belt

\*Some accessories require a mounting bracket or mounting clips. Please check with your provider to find out if the accessory you would like to order requires a mounting bracket or mounting clips.

### Safety Guidelines

The symbols below are used in the owner's manual and/or on the product to identify warnings and to notify you of important safety information. Make sure you read and understand them completely.



**WARNING!** Indicate(s) a hazardous situation which, if not avoided, could result in death or serious injury. This icon is represented as a black symbol on a yellow triangle with a black border.



**MANDATORY!** Failure to perform mandatory actions can cause personal injury and/or equipment damage. This icon is represented as a white symbol on a blue dot with a white border.



**PROHIBITED!** Indicate(s) an action(s) that should not be performed under any circumstance. Failure to adhere can cause personal injury and/or equipment damage. This icon is represented as a black symbol with a red circle and red slash.

### Safety Symbols

The symbols below identify warnings, mandatory actions, and prohibited actions. They can be found in the owner's manual and/or on the product. Make sure you understand all safety labels before operating the product. Do not remove safety labels from the product.



Read and follow the owner's manual!



Explosive conditions exist!



Indoor use only!



Use only AGM or Gel-Cell batteries!



Avoid transmitters!



Hot surface!



Pinch/Crush Hazard!



Do not place into trash!



Electrical hazard!



Corrosive chemicals inside battery!



Recycle



Do not use personal electronic devices!

# SAFETY

Your *Compass Sport*<sup>™</sup> is a battery-operated personal mobility vehicle. Please exercise caution and consideration when you are operating it. Driving your *Compass Sport*<sup>™</sup> carefully and thoughtfully will help ensure your personal safety and the safety of other people.



**MANDATORY!** Read and follow the owner's manual before operating your power chair.

## NOTICE

Before operating your *Compass Sport*, please ensure you read and understand this owner's manual in its entirety. If any uncertainty exists after reading this manual, please ask for further instruction or training from your authorized Golden Provider / Representative.

### BEFORE GETTING ON YOUR *Compass Sport*<sup>™</sup>

- ◆ Check to be certain that the power is turned off. See "Operation" on pages 21-27. This will eliminate the possibility of accidentally activating the joystick and causing injury to yourself or to others.
- ◆ Check to be certain that your *Compass Sport*<sup>™</sup> is not in freewheel mode. See the "Operation" section on page 26.
- ◆ Flip up the armrests.
- ◆ If your chair is equipped with leg rests, move them to the sides.
- ◆ If your chair is equipped with a footrest, flip it to the "up" position.

### GETTING ON YOUR *Compass Sport*<sup>™</sup>

- ◆ Carefully seat yourself comfortably and securely on the seat.
- ◆ Adjust the leg rests or flip down the footrest.
- ◆ Flip down the armrests.
- ◆ Fasten the seat belt.

### GETTING OFF YOUR *Compass Sport*<sup>™</sup>

- ◆ Make certain that the power is turned off.
- ◆ Unfasten the seat belt.
- ◆ Flip up the armrests.
- ◆ Flip up the footrest, or move the leg rests to the sides.
- ◆ Carefully stand and step away from the chair.

### MAXIMUM WEIGHT

Your *Compass Sport*<sup>™</sup> has been rated to a maximum payload (passenger and anything else being carried on the *Compass Sport*<sup>™</sup>) of **300 pounds**. Exceeding the maximum weight rating will void the warranty.



## WARNING

**Exceeding the maximum weight capacity will void your warranty and may result in injury to yourself or others.**

# SAFETY

## DRIVING ON AN INCLINE

- ◆ Drive with **caution** when attempting to negotiate any incline, even handicap access ramps.
- ◆ Try to keep your *Compass Sport™* **moving** when climbing an incline. If you do come to a stop, restart and accelerate slowly and carefully.



### WARNING

- ◆ **Always** climb or descend a gradient by driving straight up or straight down the face of the slope.
- ◆ **Do not** traverse or drive across the face of a gradient.
- ◆ **Do not** attempt to negotiate an incline that is covered with snow, ice, cut or wet grass, leaves, or any other potentially hazardous material.
- ◆ **Do not** back down an incline.
- ◆ **Do not** try to descend or climb an incline that is greater than the maximum incline stated in the specifications section of this manual.



### WARNING

**If, while you are driving down a slope, your chair starts to move faster than you feel is safe, gently release the joystick and allow your *Compass Sport™* to come to a stop. When you feel that you again have control of your power chair, adjust the speed control to a lower setting, then push the joystick forward and continue safely down the remainder of the slope.**

## MEDICATION

Always check with your physician to determine if any of the medications you are taking may affect your judgment and/or your ability to operate your *Compass Sport™*.

# SAFETY

## SAFETY RULES



### WARNING

- ◆ **Do not** attempt to use your *Compass Sport™* on an escalator. Always use an elevator.
- ◆ **Do not** carry passengers on your power chair.
- ◆ **Do not** operate your *Compass Sport™* if it is not functioning properly.
- ◆ **Use caution** when driving on soft or uneven surfaces such as grass, gravel, and on decks where there is no railing.
- ◆ **Never** drive on the roadway, except when you must cross the street.
- ◆ **Always** cross streets at intersections and use the most direct route, making sure that your path is clear and that you are visible to motor traffic.
- ◆ It is **not recommended** to drive your *Compass Sport™* up or down a step or curb that is higher than 1 1/2 inches.
- ◆ **Never** back up or down a step or curb.
- ◆ **Never** operate your *Compass Sport™* while you are under the influence of alcohol.
- ◆ **Do not** operate or store your power chair where it will be exposed to rain, snow, mist, and below freezing temperatures.
- ◆ **Do not** operate your power chair on slippery, icy or salted surfaces.
- ◆ **Never** sit on your power chair when it is in freewheel mode and on an incline or decline.
- ◆ **Do not** modify your power chair in any way that is not authorized by Golden Technologies, Inc.
- ◆ **Do not** disassemble the tire. If disassembly is required, have your authorized Golden Compass Sport provider perform any necessary maintenance or repair.
- ◆ **Do not** attempt to inflate the tires of your *Compass Sport™*. Your *Compass Sport™*, is equipped with foam-filled flat free tires that do not require inflation.
- ◆ **Never** sit on your *Compass Sport™* when it is being transported.
- ◆ **Always** fasten down your *Compass Sport™* securely with an approved tie-down system while transporting your power chair.



# SAFETY

Please be sure to follow these important warnings for the Golden Compass Sport power wheelchair:



**WARNING**

**NEVER TRANSFER ON OR OFF OF THIS POWER WHEELCHAIR USING THE SEAT BACKREST FOR SUPPORT DURING TRANSFER. THE SEAT BACK MAY FOLD DOWN AND MAY CAUSE YOU TO LOSE YOUR BALANCE AND COULD RESULT IN PERSONAL INJURY.**



**WARNING**

**DO NOT ALLOW ANYONE EXCEPT AN AUTHORIZED GOLDEN TECHNOLOGIES, INC. REPRESENTATIVE TO CONNECT ANY ELECTRICAL OR MECHANICAL DEVICE TO YOUR COMPASS SPORT™. UNAUTHORIZED ACCESSORIES WILL VOID THE WARRANTY AND MAY CAUSE INJURY.**

# EMI/RFI

The rapid development of electronics, especially in the area of communications, has saturated our environment with electromagnetic (radio) waves that are emitted by television transmitters, cellular phones, citizen's band radios (CBs), amateur radios (ham radios), wireless computer links, microwave transmitters, paging transmitters, etc. These electromagnetic (EM) waves are invisible and increase in strength the closer one gets to the source of transmission. When these energy waves act upon electrical devices and cause them to malfunction or to function in an erratic or uncontrolled manner, they are referred to as *Electromagnetic Interference* (EMI) or *Radio Frequency Interference* (RFI).

## **EMI/RFI AND YOUR *Compass Sport*<sup>TM</sup>**

All electrically powered vehicles, including power chairs are susceptible to EMI/RFI. This interference could result in abnormal, unintended movement of a power wheelchair.



**WARNING**

**Unintended movement or brake release could cause an accident or injury.**

The FDA has determined that each make and model of power chair can resist EMI/RFI to a certain level. The higher the level of immunity, the greater the degree of protection from EMI/RFI measured in volts per meter (V/m). The FDA has also determined that current technology is capable of providing 20 V/m of immunity to EMI/RFI, which would provide useful protection against common sources of interference. This product has been tested and has passed an immunity level of 20 V/m.



## **EMI/RFI RECOMMENDATIONS**

**PROHIBITED!** Do not turn on or use hand-held personal electronic communication devices such as cellular phones, walkie-talkies, and CB radios while your power chair is turned on.

- ◆ Be aware of any nearby transmitters (radio, television, microwave, etc.) on your in-tended route and avoid operating your chair close to any of those transmitters.
- ◆ Turn off the power if your *Compass Sport*<sup>TM</sup> is going to be in a stationary position for any length of time.
- ◆ Be aware that adding accessories or components or modifying your power chair may make it more susceptible to EMI/RFI.
- ◆ If unintended movement or brake release occurs, turn your power chair off as soon as it is safe to do so.
- ◆ Report all incidents of unintended movement or brake failure to your Golden representative or to Golden Technologies, Inc. at (800) 624-6374.



**WARNING**

**Turn off your power chair as soon as it is safely possible if unintended or uncontrollable motion occurs or if unintended brake release occurs.**

# SPECIFICATIONS

<b>Model</b>	<b>GP605 CC</b>	<b>GP605 SS</b>
Medicare Code	K0823	K0822
Maximum Incline	6 degrees	6 degrees
Weight Capacity	300 lbs.	300 lbs.
Maximum Speed	4 mph	4 mph
Operating Range <sup>1</sup>	24 miles	24 miles
Ground Clearance	3.25"	3.25"
Turning Radius	19.5"	19.5"
Type Batteries	2-U1	2-U1
Colors	Red, Blue	Red, Blue
Charger	Off Board	Off Board
Controller	40 Amp	40 Amp
<b>Dimensions:</b>		
Length	39"	39"
Width (outside of tires)	24"	24"
Height (ground to top of back of seat)	38" – 40"	40" – 42"
Height (ground to top of back of headrest)	45" – 50.5"	47" – 52.5"
Ground to Top of Seat	21" – 23"	19" – 21"
Number of Seat Height Positions	3	3
Size of Increments	1"	1"
<b>Weight of Unit: (assembled)</b>		
Base	92 lbs	92 lbs
Seat (18 X 18 Solid Pan Seat)		40 lbs.
Seat (18 X 18 Captain's Chair Seat)	46 lbs.	
Batteries	U1 - 22 lbs	U1 - 22 lbs
<b>Tires:</b>		
	Flat Free	Flat Free
Center Drive Wheels (2)	10"	10"
Casters (4)	6"	6"
<b>Standard Seat:</b>		
	Captain's Seat	Captain's Van/Pan
Back Height-no headrest	19"	23"
Back Height with headrest	26.5" – 29.5"	30.5" – 34.5"
Width x Depth (Adjustable Depth)	18" x 18"	18" x 18", 20" x 18", 20" x 20"
Color	Gray Vinyl	Coffee/Sand, Charcoal/Gray
Electric Rise Seat (Option)	N/A	N/A
Pneumatic Rise Seat (Option)	N/A	N/A
<b>Footrest:</b>		
	Yes	Yes
Height adjustable	3" - 7"	3" - 7"
Angle adjustable	0 – 35 degrees	0 – 35 degrees
Length adjustable (Option)	Yes	Yes
<b>Warranty:</b>		
Frame	Lifetime	Lifetime
Drive Train	13 months	13 months
Electronics <sup>2</sup>	13 months	13 months
Batteries	12 months	12 months

1. Battery range at 200 lbs., and will vary due to rider weight, drive surface, terrain, and battery type.

2. Electronics warranty excludes batteries.

Literature is current at the time of printing. Golden Technologies reserves the right to make changes to the product or literature at any time.

# ASSEMBLY/DISASSEMBLY

Your *Compass Sport™* is shipped partially disassembled in order to maximize the protection of all its parts during the shipping process. Please follow the instruction below to quickly and easily assemble the power chair for your use.

## **NOTICE**

You will need only basic tools. If you do not have the required tools, or if you do not feel capable of safely assembling your power chair, please contact your local Golden Technologies, Inc. representative.

### **Main Components**

1. Base (Frame with power module, joystick cable, wheels, footplate, and shrouds)
2. Seat assembly (Seat, headrest, arm assemblies, and accessory receiver)
3. Joystick
4. Batteries (Two – U1)
5. Seat Belt



Joystick



Batteries

# ASSEMBLY / DISASSEMBLY

## NOTICE

Your *Compass Sport™* will not power up or operate without completing the following steps.

1. Remove front and rear battery covers. Refer to “Accessing the Batteries” on page 15.
2. Make sure both battery harnesses are plugged into the power chair and locked. See figure 7 on page 15, and figure 10 on page 16.
3. Make sure the power harness is plugged into the power module and locked. See figure 1 on page 14.
4. Replace the front and rear battery covers.

## SEAT INSTALLATION/REMOVAL

Make sure the joystick cable does not interfere with the seat during installation.



WARNING

**The standard (18 x 18) seat assembly weighs about 46 pounds. Please ask for help if you do not feel capable of safely lifting that much weight. Removal of arms will significantly reduce the weight of seat.**



WARNING

**Be sure the seat is correctly installed and locked before operating your power chair.**



WARNING

**Never pull on the arms or use them as a handle to move the power chair as they could inadvertently pull out of the receiver bar causing injury.**

## INSTALLATION

1. To install the seat, align the seat post stinger on the bottom of the seat with the hole in the seat post on the chair. See figures 2 and 3 on page 14.
2. Push down on the seat and rotate the seat until it aligns and locks in place. See figure 3 on page 14.
3. Attach the arms by loosening the arm width adjustment knobs. See figure 18 on page 20. Insert the arms into the receiving tube on the seat, adjust the arms to your desired width, and tighten the arm width adjustment knobs to secure the arms in place.
4. Attach the joystick. See “Joystick Installation/Removal” on page 14.
5. Connect the joystick cable. See figure 5 on page 14.
6. Lift the backrest angle adjustment lever (See figure 4 on page 14) and while holding the lever, lift the seat back to an upright angle, then release the lever to lock the seat back in place.

## REMOVAL

1. With one hand brace the seat back. With the other hand lift the backrest angle adjustment lever and while holding the lever, lower the seat back flat against the seat.



WARNING

**Lifting the Backrest Angle Adjustment Lever will cause the back to automatically close towards the seat. Improper handling may result in injury.**

2. Disconnect the cable from the joystick. See figure 5 on page 14.
3. Remove the arms by loosening the arm width adjustment knobs, then slide each arm out to remove. See figure 18 on page 20.
4. Lift the seat up and off the seat post receiver.

# ASSEMBLY / DISASSEMBLY

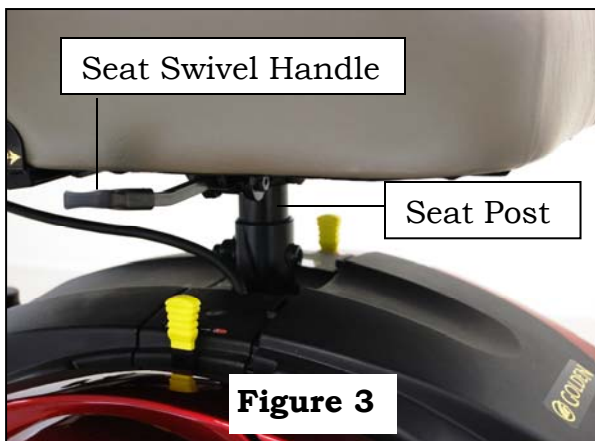
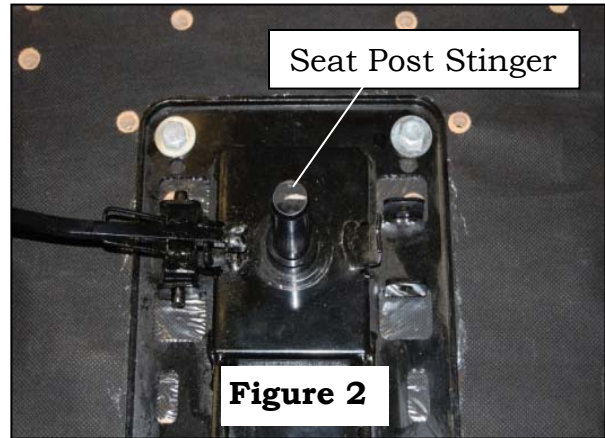
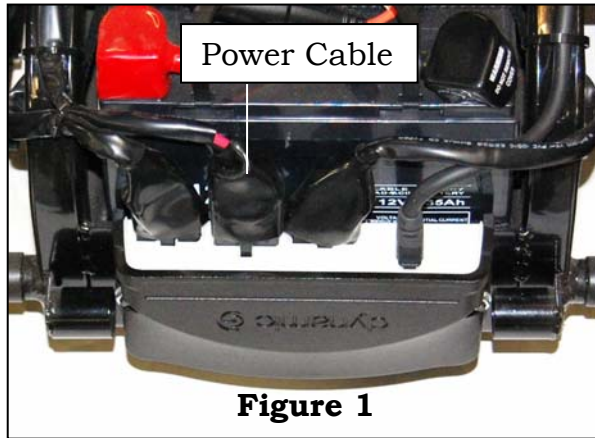

## JOYSTICK INSTALLATION/REMOVAL

1. Loosen the joystick adjustment knob. See figure 5.
2. Slide the joystick assembly into the joystick bracket to the desired position.
3. Tighten the adjustment knob.
4. Route the joystick cable up between the arm receiver tube and the seat. See figure 18 on page 20.
5. Connect the cable to the joystick, and secure the cable to the joystick bracket clip. See figure 5.
6. To disassemble, turn the joystick controller off, then reverse the process above.

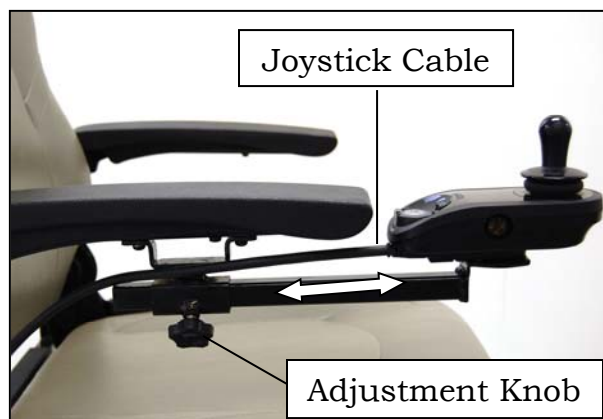

**Figure 5**

# ASSEMBLY / DISASSEMBLY

## ACCESSING THE BATTERIES

1. Remove the seat. Refer to “Seat Removal” on page 13.
2. Remove the battery covers by lifting up on the outer edge of the covers. See figure 6.

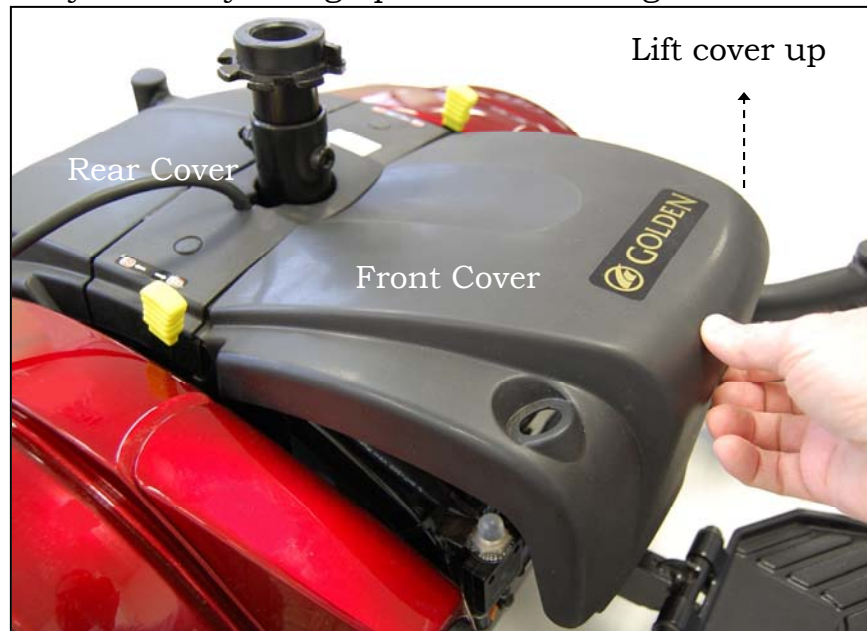

Figure 6

**NOTICE** There is a “Battery Connection Diagram” located on the inside of the rear battery cover. See figure 7.

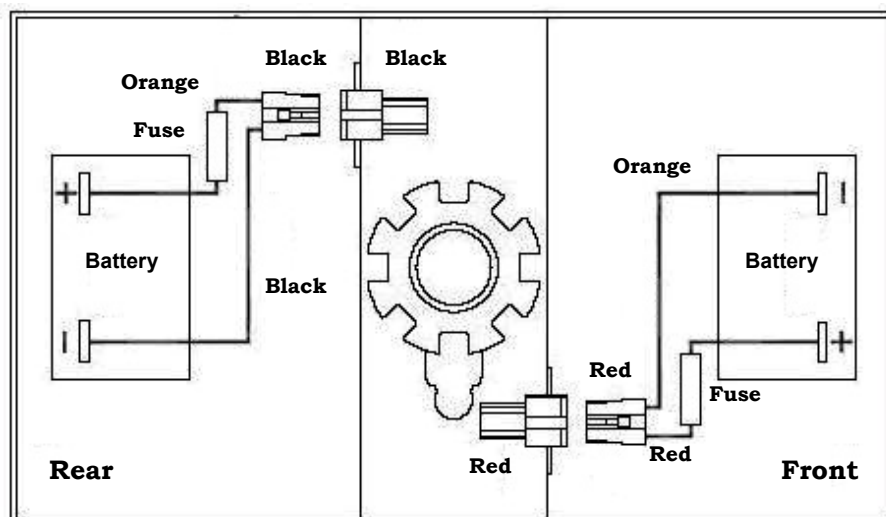

Figure 7



**WARNING** The batteries weigh 22 pounds each. (Battery weights may vary depending on the manufacturer). Please ask for help if you do not feel capable of safely lifting that much weight.

# ASSEMBLY/ DISASSEMBLY

## BATTERY INSTALLATION/REMOVAL

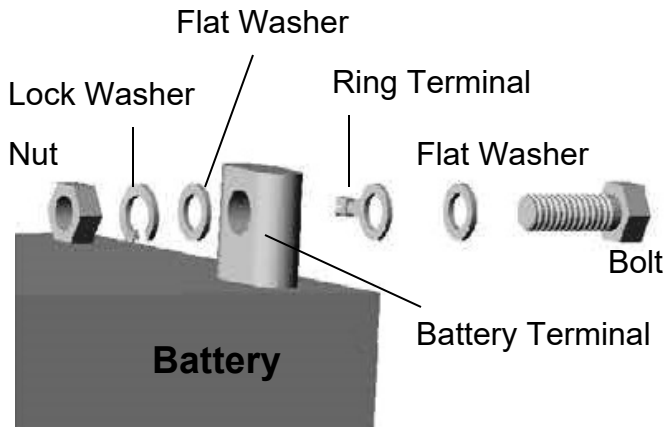

Figure 8

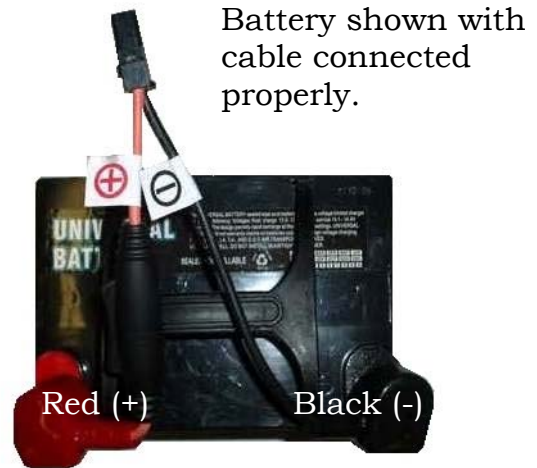

Figure 9



Figure 10

1. Use the screws, washers, and nuts provided to connect the positive (red booted) connector of each cable to the positive (+) terminal of each battery. See figure 8 and figure 9.
2. Use the screws, washers, and nuts provided to connect the negative (black booted) connector of each cable to the negative (-) terminal of each battery.
3. Place the batteries into the battery tray. Be certain the color coded connectors match. Refer to the “Battery Connection Diagram” shown in figure 7 on page 15.
4. Secure the batteries in place using the buckle straps. See figure 10.
5. Connect each color coded battery cable connector to the corresponding connector on the base unit. See figure 10.
6. Install both battery covers.
7. To disassemble, reverse the above process.



# COMFORT SETTINGS

You may be spending a great deal of time on your *Compass Sport™*. To provide you with the maximum seating comfort, Golden Technologies, Inc. has designed this power chair to incorporate the following adjustments for operator comfort.

## COMFORT SETTINGS

1. Seat height
2. Headrest height
3. Backrest angle
4. Armrest angle
5. Footrest angle
6. Footrest height
7. Armrest height
8. Armrest width
9. Joystick length



## WARNING

**Make certain that the power to your *Compass Sport™* is turned off before making any adjustments, to eliminate the risk of the joystick being accidentally bumped and activating the power chair.**

## NOTICE

If you do not feel capable of safely making these adjustments, please contact your local Golden representative.

## SEAT HEIGHT ADJUSTMENT

The seat post is a design that is adjustable in height. Adjustment is made by removing the seat post bolt, raising or lowering the seat post to the desired height and reinstalling the seat post bolt. See figure 11.

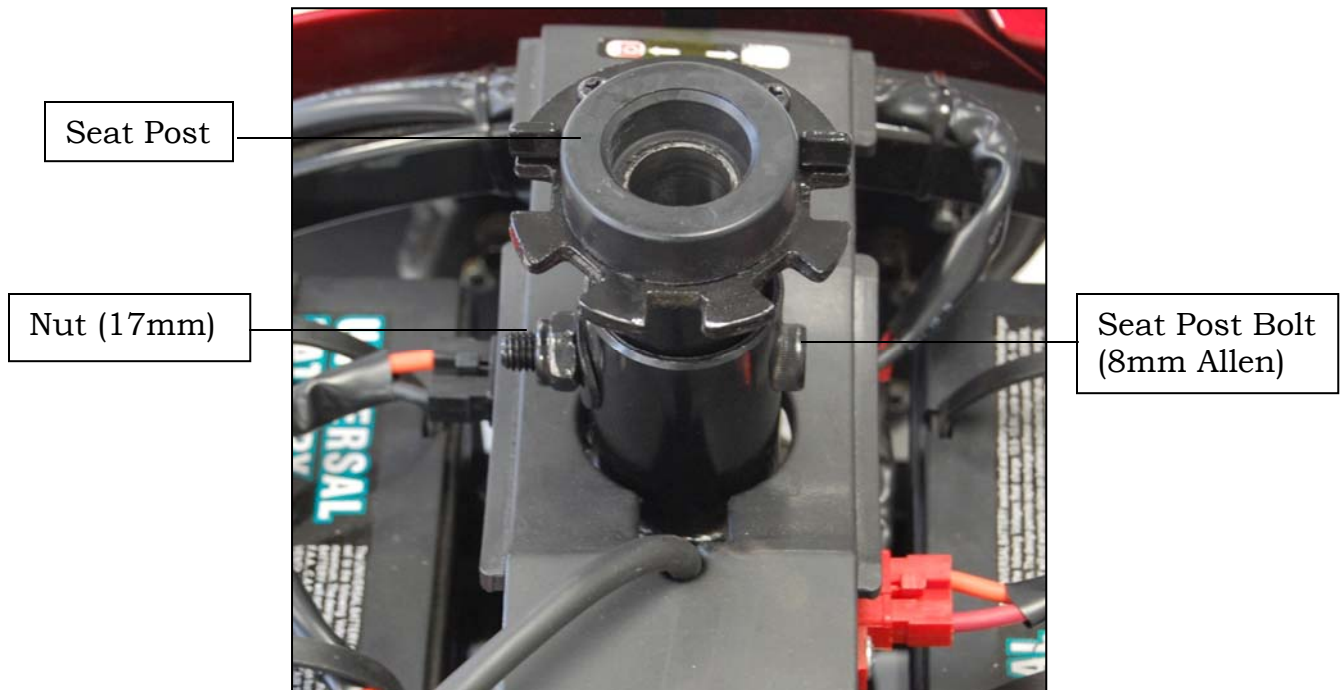

**Figure 11**

# COMFORT SETTINGS

## HEADREST HEIGHT ADJUSTMENT

1. Standing behind the chair, push and then release the clamp on the left post of the headrest while you are pulling up or pushing down on the head rest. See figure 12.
2. The headrest will “click” to a stop in one of the preset positions.
3. Repeat step 1 until the headrest is at the desired height.

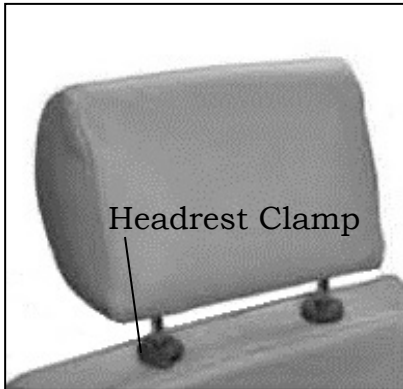

Figure 12



Figure 13

## BACKREST ANGLE ADJUSTMENT

### NOTICE

The backrest can be folded down to minimize chair height during transport.

1. Pull up on the adjustment lever (see figure 13) and push against the back rest until the backrest is in the desired position.
2. Release the lever.
3. To return the backrest to the upright position, pull up on the lever and move the backrest to the desired position.

## ARMREST ANGLE ADJUSTMENT

1. Lift armrest up. See figure 14.
2. Turn jam nut counter-clockwise with a 14mm wrench to loosen.
3. Turn the adjustment bolt using a 6mm Allen wrench to raise or lower the armrest angle. Turning the bolt counter-clockwise will raise the angle. Turning the bolt clockwise will lower the angle. Turn until desired angle is reached.
4. Re-tighten jam nut by turning clockwise.
5. Repeat steps 1-4 on the other armrest.

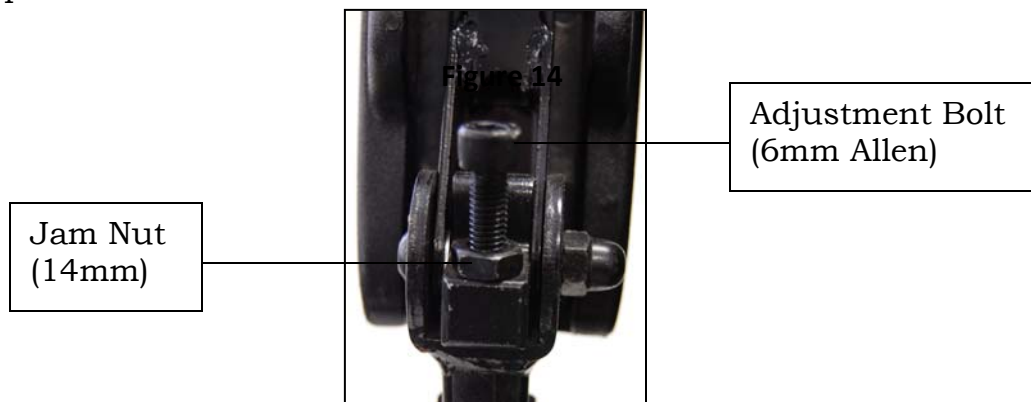

Figure 14

# COMFORT SETTINGS

## FOOTREST ANGLE ADJUSTMENT

1. Fold the footrest upward for easy access to the angle adjustment bolt. See figure 15.
2. Turn the jam nut counter-clockwise with a 17mm wrench to loosen.
3. Use a 8mm Allen wrench to turn the adjustment bolt. Turn the adjustment bolt counter-clockwise to increase the footrest angle. Turn the adjustment bolt clockwise to decrease the footrest angle.
4. When the desired footrest angle is reached, re-tighten the jam nut.

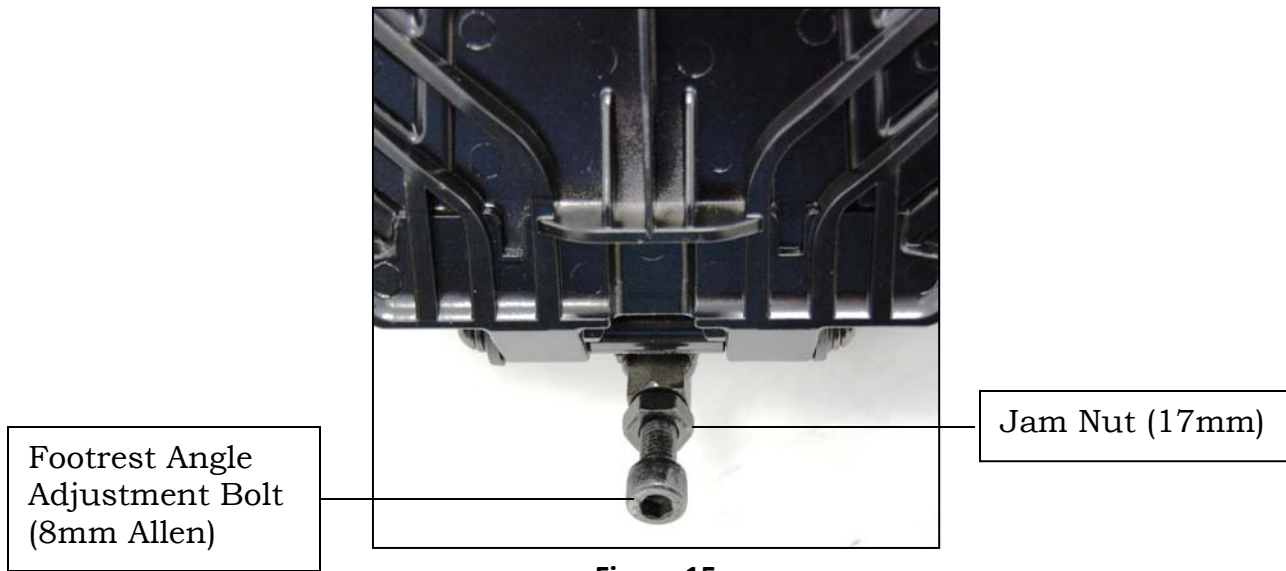

Figure 15

## FOOTREST HEIGHT ADJUSTMENT

1. Remove front cover.
2. Use a 13mm socket and 5mm Allen wrench to remove the bolts. See figure 16.
3. Slide the footrest to the desired height.
4. Align the bolt holes in the footrest and the footrest bracket.
5. Install and tighten the bolts.

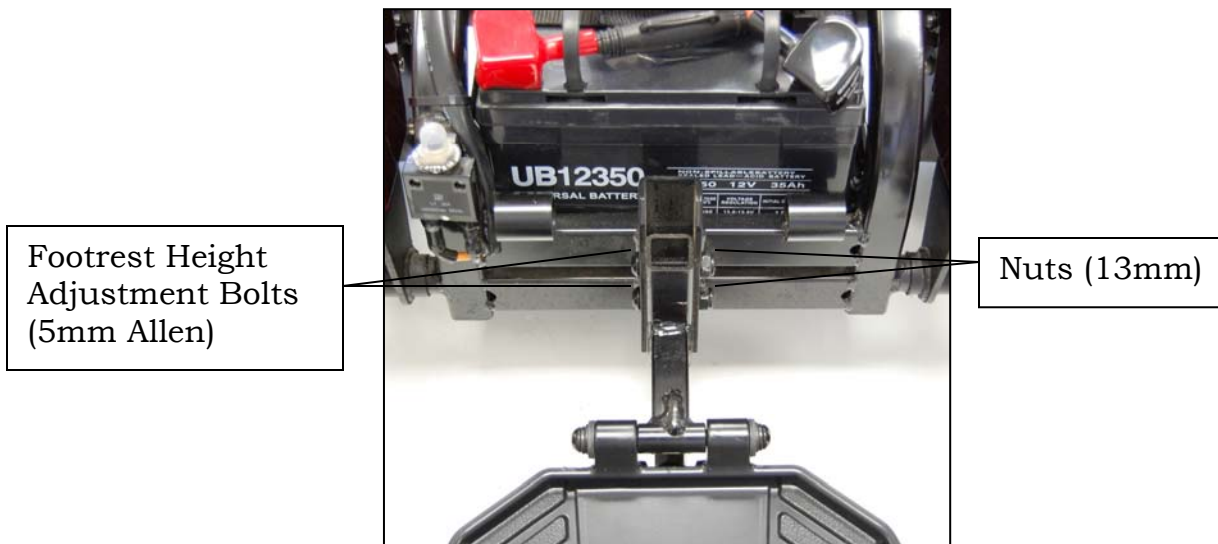
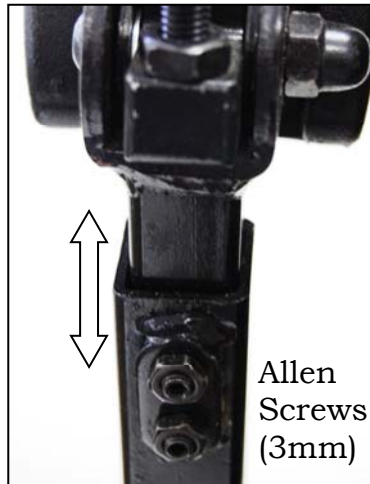

Figure 16

# COMFORT SETTINGS



**Figure 17**



**Figure 18**



**Figure 19**

## **ARMREST HEIGHT ADJUSTMENT**

1. Loosen the two armrest height adjustment screws on the outside of the armrest with a 3mm Allen wrench until you can slide the armrest up and down freely. See figure 17.
2. Raise or lower the armrest to the desired position.
3. Retighten the two adjustment screws to lock the armrest into that position.
4. Repeat steps 1-3 to adjust the opposite arm.

## **ARMREST WIDTH ADJUSTMENT**

1. Loosen the adjustment knob at the rear of the seat. See figure 18.
2. Slide the arms in or out to the desired width.
3. Tighten the adjustment knob to secure the arm.
4. Repeat steps 1-3 to adjust the opposite arm.

## **JOYSTICK BRACKET LENGTH ADJUSTMENT**

1. Loosen the adjustment knob. See figure 19.
2. Slide the joystick holder in or out to the desired position.
3. Tighten the adjustment knob.

# OPERATION

Your *Compass Sport™* is simple to operate. However, for your safety and the safety of others, Golden Technologies, Inc. recommends that you carefully read and understand the following operating instructions. We also recommend that you practice operating your *Compass Sport™* in an area free of any obstacles. Once you have gained confidence in your ability to control your power chair, you will more easily be able to operate it in normal daily conditions.

## **CAUTION**

Before turning on the power of your *Compass Sport™*, take note of your environment and set your speed control accordingly. (See “The Speed Control Buttons” figure 20) For indoor driving, we recommend that you select the lowest speed setting. For outdoor driving, we recommend that you select a speed setting at which you feel comfortable, safe, and in control of your power chair. Familiarize yourself with the features of your *Compass Sport™* described below and follow the instructions to safely operate your power chair.



**Figure 20**



**WARNING** The surface of the joystick can potentially get hot when it is exposed to strong sunlight for long periods.

# OPERATION

## DRIVING: Joystick Power On/Off Button



To turn on the power to your *Compass Sport™*, press the power button. If the system is healthy, the Status indicator (through the Power Button) will light up green, and the Battery Gauge will display the current battery status.

Power Off

If there is a fault with the system when powering up, the status indicator will indicate a fault with a series of red flashes (see “Diagnostics”) on page 25. If the fault is one that prevents the power chair from driving, then the battery gauge will flash continuously.



To turn off the power to your *Compass Sport™*, press the power button; the system will power down and the Status indicator will switch off.

Power On

## NOTICE

In the unlikely event that the power chair is in a runaway situation, press the power button to perform an EMERGENCY STOP.

## Drive Inhibit Indication

Drive inhibit mode is indicated by the battery gauge with a right-to-left light sequence.

The light sequence starts with the green LED on the right-hand side, and one-by-one, each LED will switch on then off. When the sequence completes at the left-most red LED, it begins again at the right-hand side.

The light sequence continues until the error condition has been cleared.

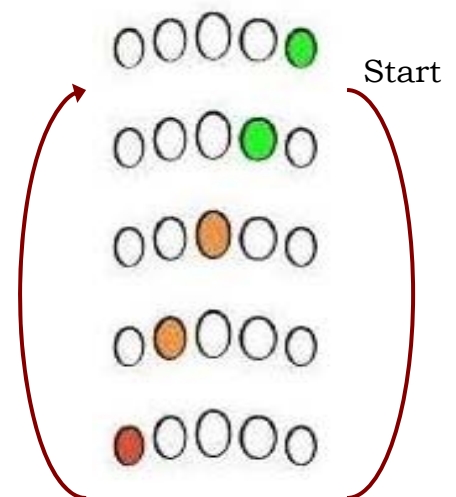

Drive Inhibit Light Sequence

## OONAPU

OONAPU (“**Out Of Neutral At Power Up**”) is a safety feature that prevents accidental movement of the wheelchair, either when powering up, or when the wheelchair comes out of an inhibit state.

If the LINX LE System is turned on (or comes out of an inhibit state) while the joystick is not in the center position, an OONAPU **warning** is displayed. During an OONAPU warning, the battery gauge LEDs will flash continually to alert the user, and the chair will not drive. If the joystick is returned to the center position within five seconds, the warning will clear and the wheelchair will drive normally.

However, if the joystick remains out of neutral for longer than five seconds, an OONAPU **error** will occur; the error is displayed by the Status indicator flashing red, and the chair will not drive. To clear the error, return the joystick to the neutral position and power the unit off and then on again.

# OPERATION

## The Joystick

The joystick (see figure 20 on page 21) controls the speed (up to the maximum limit set by the speed dial) and direction of your power chair.

Pushing the joystick away from the neutral (center) position will move your *Compass Sport™* in the direction that the joystick is pushed.

- ◆ The farther forward or backward you push the joystick, the faster your power chair will go.

To operate your power chair, gently push the joystick in the direction in which you want to travel.

- ◆ Gentle operation of the joystick will provide you with smoother changes in speed and direction.
- ◆ Sharp or jerky operation of the joystick will result in quick and drastic changes in direction and speed.

### NOTICE

For your safety, the controller automatically sets the reverse speed, acceleration, and deceleration in proportion to the speed control setting.

### NOTICE

When you are not pushing on the joystick, or when you release the joystick, the joystick will automatically return to the neutral position, the chair will decelerate, as the electromagnetic brakes are applied, and come to a smooth stop.

## Controlling Maximum Speed

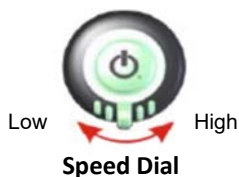

The speed dial allows you to limit the maximum speed of the power chair (that is, the speed when the joystick is fully deflected) to suit your preference and environment.

The dial offers 10 discrete steps between the lowest speed (dial set to the left) and the highest speed (dial set to the right).

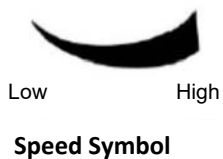

As a visual reminder, a speed symbol (shown left) is positioned just below the speed dial to indicate the low and high positions of the speed dial.



The horn button is located above the power button. Press the horn button to sound the horn. The horn will sound for as long as the horn button is pressed.

# OPERATION

## The Battery Gauge

The battery gauge comprises five different LEDs (1 x RED, 2 x AMBER, 2 x GREEN), located above the horn button. The number of LEDs lit depends on the status of the battery, as shown.

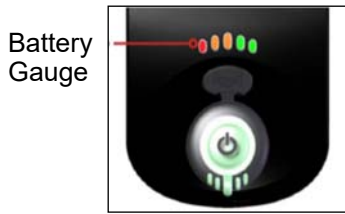

Battery Gauge

The battery gauge LEDs are also used to display charging information. Refer to “Battery Charging” on pages 28-29.

## Normal Operation

### Battery Gauge

### Battery Level



Fully charged



Consider charging the battery



Battery needs charging

## High voltage warning

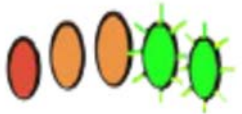

A high voltage warning is indicated by all LEDs on, and the green LEDs flashing. This occurs when the battery voltage level has risen above the high voltage warning set-point.

## Low voltage warning



A low voltage warning is indicated with the left-most LED flashing. This occurs when the battery voltage level has dropped below its low voltage warning set-point. **Charge the batteries immediately.**

## Cut-off voltage



When the battery voltage drops below the battery cut-off voltage:  
The first (red) LED will flash on the battery gauge.  
The status indicator (under the power button) will display a flash code 2.  
The horn will sound once every 10 seconds.



# OPERATION / DIAGNOSTICS

## *For Compass Sport Units with the LiNX Controller*



If, when powered up, there is an error with the system, then the status indicator will flash red. The number of flashes will indicate the type of error. These are described in the table below.

### **Status Indicator**

<b>Flash Code</b>	<b>Description</b>	
1	Remote / joystick error	Check LiNX connections and wiring. Replace the LiNX Control Unit.
2	Network or configuration error	Check LiNX connections and wiring. Replace the LiNX Control Unit.
3	Left motor error	Check the left motor, connections and cabling.
4	Right motor error	Check the right motor, connections and cabling.
5	Left park brake error	Check the left park brake, connections and cabling.
6	Right park brake error	Check the right park brake, connections and cabling.
7	Module error (other than Remote)	Check LiNX connections and wiring. Replace the Power Module.

### **NOTICE**

The LiNX modules are not user serviceable. Do not attempt to repair LiNX modules.

# OPERATION

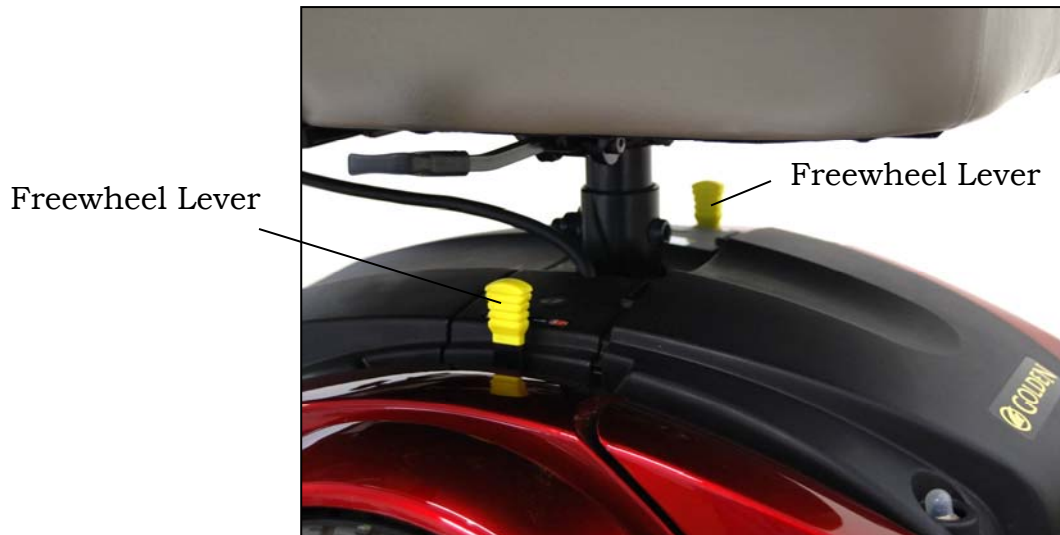

**Figure 21**

## **FREEWHEEL MODE**

- ◆ To disengage the gears and put your power chair in freewheel mode, pull the freewheel levers forward towards the front of your chair. See figure 21.
- ◆ To re-engage the gears and take your chair out of freewheel mode, push the levers back towards the rear of your chair. See figure 21.



**WARNING** Never put your power chair in freewheel mode when it is on a slope or incline of any type.



**WARNING** Never put your power chair in freewheel mode while you are operating your power chair.

## **THERMAL ROLLBACK**

Your *Compass Sport™* is equipped with a safety system. A microprocessor monitors the operating temperatures of the controller. In the event of excessive heat occurring in the controller, the controller will decrease the speed of your chair. This is done to reduce the load on the electrical system and allow the components to dissipate heat. The controller will automatically set the chair's speed back to full normal when the operating temperature returns to normal levels.

## **THE MAIN CIRCUIT BREAKER**

The main circuit breaker is another safety feature incorporated into your *Compass Sport™*. This device monitors the amount of current being drawn from the batteries when the chair is in use. When the motors are heavily strained and too high a current draw is being placed on the batteries, the main circuit breaker will trip and bring your chair to a stop. See figure 22 on page 27.

# OPERATION

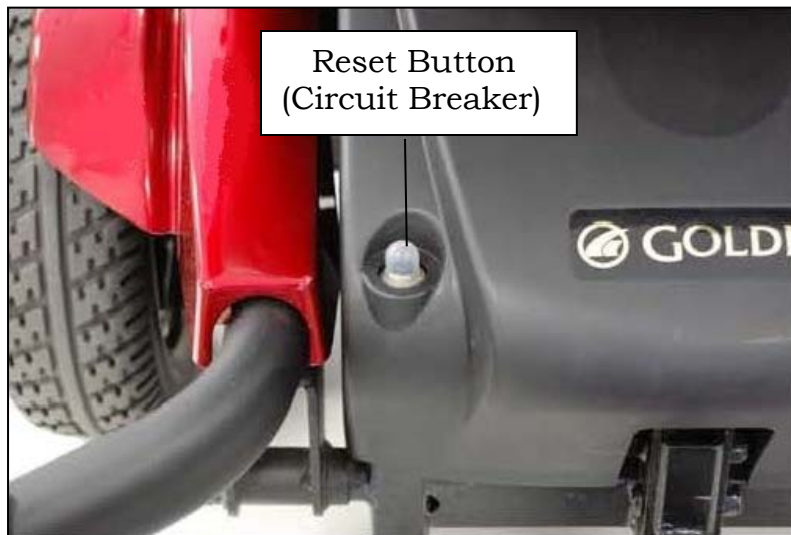

**Figure 22**

## **Reset Button**

If the main circuit breaker trips, please wait for approximately 1 minute and then push the reset button to reset the main circuit breaker. See figure 22.

## **NOTICE**

Usually, the thermal rollback feature is more sensitive than the main circuit breaker. We recommend that you turn off the power to the chair and wait for five minutes when the chair suddenly loses speed or power. Doing so will allow the overheated electrical components to cool to their normal operating temperatures.

## **Additional features available for your *Compass Sport*™**

### **Length Adjustable Footrest – Optional Equipment Required**

*The Compass Sport*™ optional footrest will provide you with the ability to extend the footrest by simply adjusting two screws.

### **Footrest Extension – Optional Equipment Required**

*The Compass Sport*™ optional footrest extension will provide you with the ability to extend the footrest even further for added foot space when required by simply sliding the extension out to the desired position.

### **Swing-away Desk Arm – Optional Equipment Required**

*The Compass Sport*™ swing-away desk arm option will provide you with the convenience of positioning your chair close to a work surface such as a table or desk.

To swing the desk arm simply push on the side of the joystick until the joystick swings to the retracted position.

# BATTERY CHARGING



## WARNING

**You must use only the charger that is supplied with your *Compass Sport*<sup>™</sup>. The use of any other charger on this power chair will void the warranty. Using unauthorized chargers may also result in severe damage to the batteries and/or damage to the chair. Using the wrong charger may also be a hazard.**

## Operational Range

Depending on the use, the terrain, and the driving conditions, the U1 batteries of your *Compass Sport*<sup>™</sup> will provide up to 19.5 miles of operation with a user weight of 300lbs.



**WARNING!** Corrosive chemicals contained inside battery.  
Explosive battery conditions exist.



**WARNING!** Charger surface can become HOT.  
Electrical hazard!

## BATTERIES AND CHARGING

Battery maintenance is the most important part of maintaining your power chair. Keeping the batteries fully charged helps to extend battery life. Use the following guidelines to help keep your batteries in optimum condition.

**IMPORTANT!** New batteries **MUST** be fully charged prior to the initial use of your power chair.

**Charge new batteries for 12 hours even if the battery gauge already shows a full charge. This is to condition your new batteries for maximum performance.**

• For daily use, keep batteries fully charged. We recommend that you plug in the off-board charger after each use and charge 6-8 hours.

**“For best results please charge your batteries overnight after every use.”**

• If you are not going to use the power chair for more than a week, **fully charge** the batteries and then disconnect them from the power chair. See figure 9 on page 15.

## NOTICE

### Charging Guidelines Checklist to Maximize Battery Life

- ✓ Use only the automatic off-board charger supplied for all routine charging.
- ✓ Never use an automotive or wet type charger.
- ✓ Avoid deep discharges and never drain the batteries completely.
- ✓ Do not leave batteries in a low state of charge for extended periods. Charge a discharged battery as soon as possible.
- ✓ Fully recharge batteries regularly.
- ✓ Always store batteries fully charged.
- ✓ Check stored batteries once a month and recharge as necessary.

# BATTERY CHARGING

## CHARGING THE BATTERIES

Your *Compass Sport's* charging system is designed for your safety and for your convenience. Follow the steps below to recharge the batteries.

1. Position your *Compass Sport™* close to a standard wall electrical outlet.
2. Turn off the power on the joystick.
3. Remove the charger from its storage pouch.



**WARNING**

**The charger should not be plugged into the electrical outlet or powered up at this point in the process. Please check before proceeding.**

4. Insert the matching charger plug into the joystick's charging socket that is located on the outside edge of the joystick. See figure 23. **IMPORTANT: Failure to align pins before inserting the plug in the correct orientation may damage the joystick and render your wheelchair non-operational.**
5. Insert the plug at the other end of the charger power cord into a standard electrical wall outlet.
6. Disconnect the charger power cord from the wall outlet and from the joystick charging socket when the batteries are fully charged.

## NOTICE

The batteries should be fully charged in approximately eight hours. A full charge is indicated when the battery charger LED is green and the 5 battery gauge LEDs (1 x RED, 2 x AMBER, 2 x GREEN) on the joystick are illuminated.

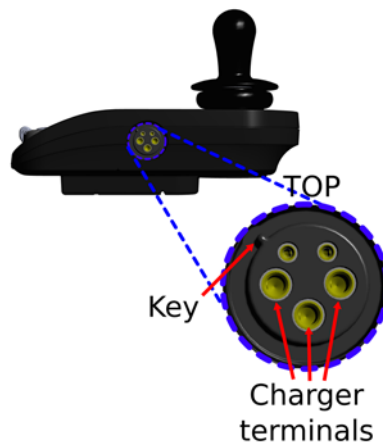

**Figure 23**

## Battery Charging

The battery gauge will indicate the system is being charged by cycling between a left-to-right light sequence, and then display the approximate battery charge state at the end of the sequence.

Driving is prevented (inhibited) while the system is being charged.

The system does not have to be powered up when charging the battery, however, if it is not powered up, then the battery gauge will not display the charging state/light sequence.

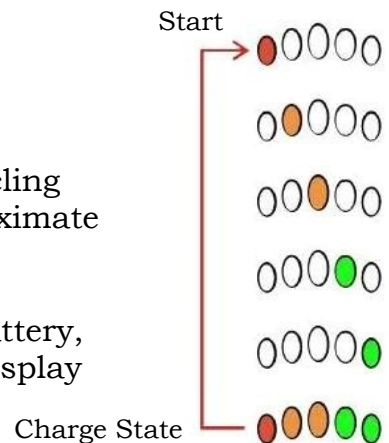

# CARE AND MAINTENANCE

## ROUTINE MAINTENANCE

Your power chair requires a minimal amount of care and maintenance. If you do not feel confident in your ability to perform the maintenance listed below, you can schedule an inspection and maintenance with your provider.

- ✓ Make sure your batteries are fully charged daily. See “Battery Charging”.
- ✓ While turned off, check the joystick control daily for damage, and make sure it returns to the neutral position. If any defects are observed, contact your provider. **Do not attempt to repair it yourself!**
- ✓ Inspect the seating system, armrests, footplate, and front riggings daily for loose hardware, excessive wear, or damage. If any defects are observed, contact your provider.
- ✓ Regularly inspect your power chair’s tires for signs of wear.
- ✓ Regularly inspect all exposed harnessing and connections for wear, damage, and corrosion. Have your provider repair or replace any damaged harness or connector.
- ✓ Keep all the electrical components (charger, joystick control, and electronics) free from moisture. If any of these items do become exposed to moisture, let them dry thoroughly before attempting to operate your power chair again.
- ✓ Periodically check all fasteners for tightness, wear, and corrosion. If any of these are present, turn off the power chair and contact your provider.



### WARNING

**Be careful of pinch points and sharp metal parts (wear gloves).**

- ✓ All wheel bearings are permanently lubricated and sealed. No additional lubrication is required.

We recommend that you check the following:

**Tire Tread:** Regularly visually inspect the tire tread. If the remaining tread is less than 1/32 of an inch, have your local Golden representative replace the worn tires.

**Joystick and Controller:** Protect the joystick and controller from adverse weather conditions. Moisture will damage the controller and void your power chair’s warranty.

**Cleaning:** Use only a water-dampened soft cloth to clean the ABS shroud. The shroud has a protective coat that is very easy to maintain.



### WARNING

**Do not use free-flowing water to clean your Compass Sport™. Water and extreme temperatures are the main elements that can adversely affect your power chair and its performance.**

#### **Water, Rain, Sleet, and Snow**

Water, in any form, will cause electronic malfunction or corrosion of the electrical components, connections, and the chair frame.

#### **Temperature**

- ◆ At extremely low temperatures, the batteries of your power chair may freeze, preventing your *Compass Sport™* from operating.
- ◆ At extremely high temperatures, your power chair may operate at slower speeds due to the controller’s thermal rollback feature that is designed to prevent damage to the motors and to the other electrical components of the chair.

## XII. WARRANTY



### Consumer Limited Warranty *Power Wheelchairs*

Golden Technologies has provided information throughout the owner's manual in regards to proper usage and care of your power wheelchair. Failure to adhere to this information will void the warranty of the power wheelchair, its parts and the batteries supplied by Golden Technologies

The following warranty is granted only to the INITIAL Consumer who has purchased our product and commences on the Date of Purchase by the Consumer from an Authorized Golden Technologies' Provider. The Consumer must have a warranty registration card filed with Golden Technologies to receive service.

The warranty covers the following power wheelchair models unless otherwise noted:

- ◆ LiteRider Envy GP162
- ◆ Alante' GP207
- ◆ Compass HD GP620
- ◆ Alante Sport' GP205
- ◆ Compass Sport GP605

#### *Five-Year Limited Warranty:*

For the period of five years from the date of purchase, in the event of defective materials or workmanship, Golden Technologies will repair or replace at our option any of the following **structural frame components** found to be defective by an authorized Golden Technologies representative:

- ◆ Steel Frame\*
- ◆ Frame Welds\*
- ◆ Seat Post\*

*\*The GP605 is warranted for LIMITED LIFETIME*

#### *Thirteen Month Limited Warranty*

For the period of thirteen months from the date of purchase, in the event of defective materials or workmanship, Golden Technologies will repair or replace at our option any of the following **structural frame components** found to be defective by an authorized Golden Technologies representative:

- ◆ Caster Beam
- ◆ Caster Forks
- ◆ Footrest
- ◆ Anti-Tip Forks
- ◆ Armrests

For the period of thirteen months from the date of purchase, in the event of defective materials or workmanship, Golden Technologies will repair or replace at our option any of the following **drive train components** found to be defective by an authorized Golden Technologies representative:

- ◆ Motor/Gearbox Assembly
- ◆ Brake Assembly (electrical function only)

**Note: An increase in operating noise of the motor/gearbox DOES NOT constitute a defect. With normal wear and tear, operating noise is expected to increase.**

For the period of thirteen months from the date of purchase, in the event of defective materials or workmanship, Golden Technologies will repair or replace at our option any of the following **electronic assemblies** found to be defective by an authorized Golden Technologies representative:

- ◆ Electronic Controller
- ◆ Battery Charger
- ◆ Wire Harness(es) (excludes boot covers)

**Note: While charging batteries, it is normal for the battery charger to heat up. Heat coming from the battery charger DOES NOT constitute a defect.**

For the period of thirteen months from the date of purchase, in the event of defective materials or workmanship, Golden Technologies will repair or replace at our option any of the following **parts** found to be defective by an authorized Golden Technologies representative:

- ◆ Bearings
- ◆ Rubber Components
- ◆ Plastic Components
- ◆ Bushings
- (excludes tires and all wear parts)
- (excludes body & all wear parts)
- ◆ Seat swivel mechanism

#### *Twelve Month Limited Warranty*

For the period of twelve months from the date of purchase, in the event of defective materials or workmanship, Golden Technologies will replace the **batteries supplied by Golden Technologies** if found to be defective by an authorized Golden Technologies representative.

## XII. WARRANTY



### **Consumer Limited Warranty *Power Wheelchair (continued)***

Items not mentioned or listed are covered at the discretion of Golden Technologies. Any accessories, standard or optional, supplied by Golden Technologies, are covered for a period of one year from the date of purchase with the particular unit.

#### ***Warranty Exclusions:***

Golden Technologies does not provide warranty on any of the following items which may require replacement due to the normal wear and tear of day to day usage:

- ◆ Tires and Tubes
- ◆ ABS Plastic Shrouds
- ◆ Armrest Pads
- ◆ Motor Brushes
- ◆ Bulbs/Fuses
- ◆ Battery Cases
- ◆ Brake Pads
- ◆ Upholstery

This warranty also excludes the following:

- ◆ Loss or theft of components
- ◆ Damage caused by:
  - Battery fluid spillage or leakage.
  - Abuse, misuse, accident or negligence.
  - Improper operation, maintenance or storage.
  - Commercial use or use other than normal.
  - Repairs and/or modifications made to any part without the specific consent of Golden Technologies.
  - Exceeding the specified weight capacity of the unit.
  - Accessories other than those supplied or approved by Golden Technologies.
  - Failure to adhere to the product instructions.
  - Acts of Nature, such as lightning strikes, earthquakes, etc....
  - Circumstances beyond the control of Golden Technologies.
- ◆ **ANY PARTS ALTERED OR REPAIRED BY UNAUTHORIZED PERSON.**

#### ***Warranty Service:***

Warranty Service must be performed by an authorized Golden Technologies representative. Golden Technologies reserves the right to replace warranted part(s) with refurbished or new part(s) at our discretion. All labor charges, service calls, transportation costs or any other charge(s) associated with the installation of any warranted part(s) are the responsibility of the consumer. Warranty is for the replacement of the parts only and does not include freight for the replacement parts. Consumers are not to return any item(s) to Golden Technologies without prior written authorization. Any damages incurred while warranted part(s) are in transport are the sole responsibility of the consumer.

#### **There is no other express warranty.**

Implied warranties, including those of merchantability and fitness for a particular purpose are excluded. Liabilities for consequential damages are excluded.

This warranty gives you specific rights and you may also have other rights which may vary from state to state.



# GOLDEN PRODUCT REGISTRATION

Register Now To Lock In Your Warranty and Receive Important Product Updates

**SAVE TIME - REGISTER ONLINE: [WWW.GOLDENTECH.COM](http://WWW.GOLDENTECH.COM)**

## SERIAL NUMBER

*Most Lift Chairs Have On Controller Wire or Back Rail of the Metal Frame  
Most Scooters & Powerchairs On Seat Post, Under/On Battery, or Under Carpet*

--	--	--	--	--	--	--	--	--	--	--	--	--	--	--	--	--	--	--	--

## PRODUCT MODEL NUMBER

*Most Lift Chairs Start with PR (PR401, PR510, etc)  
Most Scooters with G (GA, GB, GC, GL, GR, etc) Most Powerchairs with GP*

--	--	--	--	--	--	--	--	--	--	--	--	--	--	--	--	--	--	--	--

## PURCHASE DATE

--	--	--	--	--	--	--	--	--	--	--	--	--	--	--	--	--	--	--	--

## FIRST NAME

--	--	--	--	--	--	--	--	--	--	--	--	--	--	--	--	--	--	--	--

## LAST NAME

--	--	--	--	--	--	--	--	--	--	--	--	--	--	--	--	--	--	--	--

## ADDRESS

--	--	--	--	--	--	--	--	--	--	--	--	--	--	--	--	--	--	--	--

## ADDRESS LINE 2

--	--	--	--	--	--	--	--	--	--	--	--	--	--	--	--	--	--	--	--

## CITY

--	--	--	--	--	--	--	--	--	--	--	--	--	--	--	--	--	--	--	--

## STATE / PROVINCE ZIP / POSTAL CODE

--	--	--	--	--	--	--	--	--	--	--	--	--	--	--	--	--	--	--	--

## E-MAIL ADDRESS

--	--	--	--	--	--	--	--	--	--	--	--	--	--	--	--	--	--	--	--

## PROVIDER NAME

--	--	--	--	--	--	--	--	--	--	--	--	--	--	--	--	--	--	--	--

## PROVIDER'S ADDRESS

--	--	--	--	--	--	--	--	--	--	--	--	--	--	--	--	--	--	--	--

## ADDRESS LINE 2

--	--	--	--	--	--	--	--	--	--	--	--	--	--	--	--	--	--	--	--

## CITY

--	--	--	--	--	--	--	--	--	--	--	--	--	--	--	--	--	--	--	--

## STATE / PROVINCE

--	--	--	--	--	--	--	--	--	--	--	--	--	--	--	--	--	--	--	--

## ZIP / POSTAL CODE

--	--	--	--	--	--	--	--	--	--	--	--	--	--	--	--	--	--	--	--

## COUNTRY

--	--	--	--	--	--	--	--	--	--	--	--	--	--	--	--	--	--	--	--

Product comments:

Rate Provider Experience (Circle One - 1 Bad, 5 Great)

**1 2 3 4 5**

Fold Here First

---

---

---

---

Place  
Stamp  
Here

Golden Technologies  
401 Bridge St.  
Old Forge, PA 18518

---

Fold Here Second





401 Bridge Street, Old Forge PA 18518  
Tel: (800) 624-6374 Fax: (800) 628-5165  
[www.goldentech.com](http://www.goldentech.com)