

MAXI 500
Instruction for Use

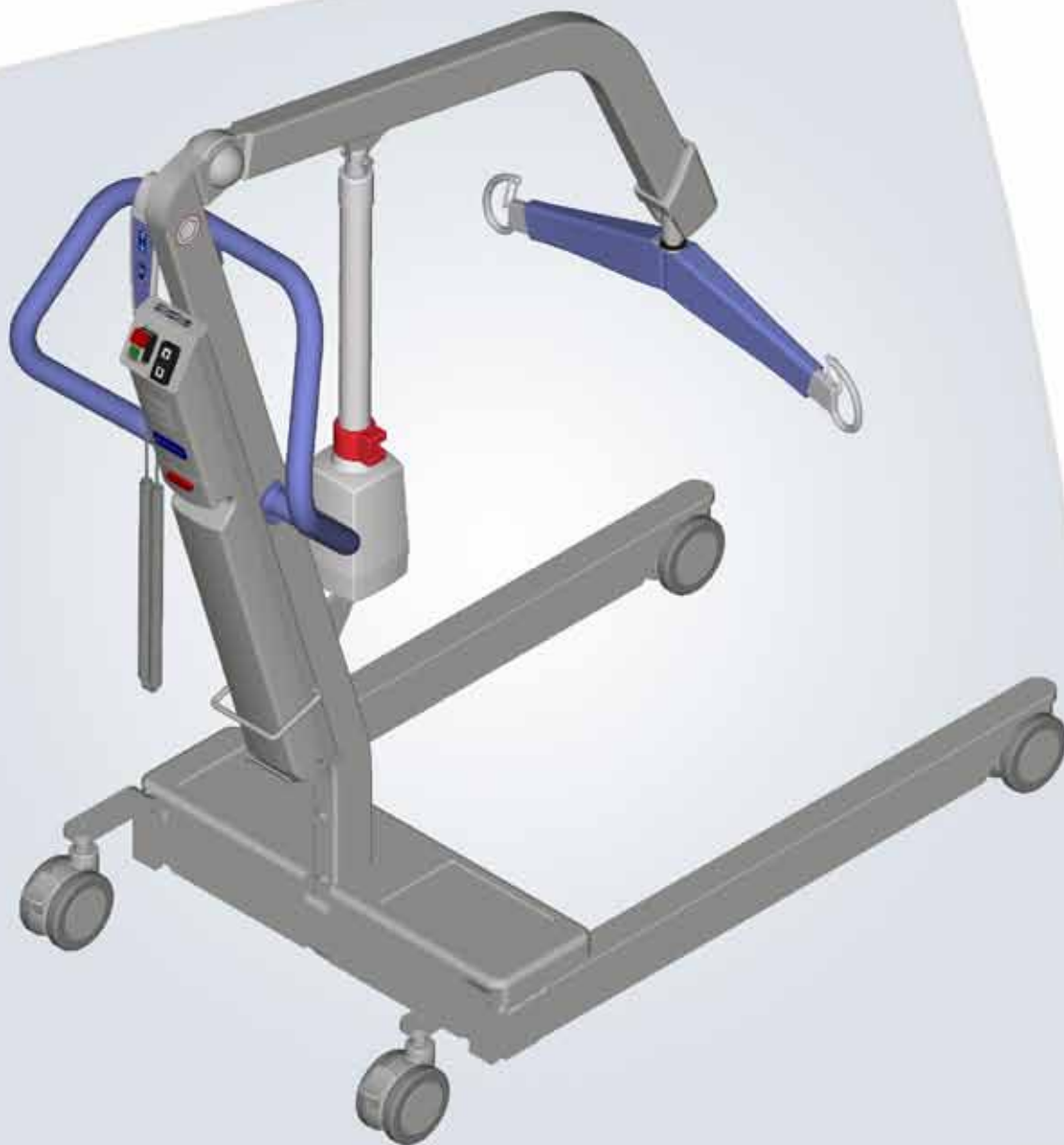

CE

Design Policy and Copyright

® and ™ are trademarks belonging to the ArjoHuntleigh group of companies.
© ArjoHuntleigh 2013.

As our policy is one of continuous improvement, we reserve the right to modify designs without prior notice. The content of this publication may not be copied either whole or in part without the consent of ArjoHuntleigh.

Table of Contents

| | |
|---|-----------|
| Foreword | 1 |
| Please Read this Manual Thoroughly! | 1 |
| Service and Support | 1 |
| Manufacturer Information | 1 |
| Definitions Used in this Manual | 1 |
| Safety Instructions | 2 |
| Intended Use | 2 |
| Operational Life | 2 |
| Important Safety Instructions | 2 |
| Policy on Number of Staff Members Required for Patient Transfer | 3 |
| Safe Working Load (SWL) | 3 |
| Battery and Battery Charger Safety Practices | 4 |
| Shock Prevention | 4 |
| Fire and Explosion Prevention | 4 |
| Human and Environmental Safety Practices | 4 |
| <i>Homecare Environment Considerations</i> | 4 |
| Symbols Used | 5 |
| General Symbols | 5 |
| Charger Related | 5 |
| Product Description | 6 |
| How to use the MAXI500 | 7 |
| Adjusting Legs Spreading | 7 |
| Brakes | 7 |
| Emergency Stop | 7 |
| Boom Control | 7 |
| <i>To Raise the Patient</i> | 7 |
| <i>To Lower the Patient</i> | 7 |
| Moving the MAXI500 | 8 |
| Emergency Lowering | 8 |
| Automatic Cut-out | 8 |
| <i>During lifting</i> | 8 |
| <i>During lowering</i> | 8 |
| Hour Meter | 8 |
| Battery Charge Indicator | 9 |
| Battery Charging | 9 |
| Inserting/Removing the Battery Pack | 9 |
| Model 1000 Scale (optional) | 10 |
| <i>Using the Model 1000 Scale</i> | 10 |
| Clip Slings Application | 11 |
| Clip Sling Compatibility | 11 |
| Sling Selection | 12 |
| Spreader Bar Compatibility | 12 |
| Attaching the Sling to the DPS | 13 |
| Detaching the Sling from the DPS | 13 |
| Operating the DPS | 13 |
| Transferring Patients Using Clip Slings | 14 |
| <i>Lifting Patient from a Seated Position</i> | 14 |
| <i>Lowering Patient to a Seated Position</i> | 14 |
| <i>Lifting Patient from a Bed</i> | 15 |
| <i>Lowering Patient to a Bed</i> | 15 |
| <i>Lifting Patient from the Floor</i> | 16 |
| <i>Lowering Patient to the Floor</i> | 16 |

| | |
|---|-----------|
| Loop Slings Application | 17 |
| Compatible Loop Slings..... | 17 |
| Sling Selection..... | 18 |
| Spreader Bar Compatibility..... | 18 |
| Attaching the Sling to the Spreader Bar | 18 |
| <i>Positioning the Patient</i> | 18 |
| <i>Attachment Methods</i> | 19 |
| Transferring Patients Using Loop Slings | 20 |
| <i>Lifting Patient from a Seated Position</i> | 20 |
| <i>Lowering Patient to a Seated Position</i> | 20 |
| <i>Lifting Patient from a Bed</i> | 21 |
| <i>Lowering Patient to a Bed</i> | 21 |
| <i>Lifting Patient from the Floor</i> | 22 |
| <i>Lowering Patient to the Floor</i> | 22 |
| Care and Maintenance | 23 |
| Lift Cleaning and Care | 23 |
| Preventive Maintenance Schedule..... | 24 |
| Troubleshooting | 26 |
| Labels on the Lift..... | 27 |
| Technical Specifications..... | 28 |
| <i>Dimensions</i> | 29 |
| Electromagnetic Compatibility..... | 30 |
| Electromagnetic Compliance | 30 |
| Electromagnetic Emissions..... | 30 |
| Electromagnetic Immunity | 31 |

Please Read this Manual Thoroughly!

The information in this manual is crucial to the proper use and maintenance of the MAXI500 floor lift. It will help protect your product as well as ensure that it performs to your satisfaction.

Lifting and transferring a person always presents a potential risk. This manual contains safety related information that must be read and understood to help prevent injuries.

ArjoHuntleigh strongly advises and warns that to avoid injuries that can be attributed to the use of inadequate parts, only parts designated by ArjoHuntleigh should be used on product and other appliances supplied by ArjoHuntleigh.

Unauthorized modifications on any ArjoHuntleigh product may affect its safety. ArjoHuntleigh will not be held responsible for any accidents, incidents or lack of performance that occur as a result of any unauthorized modification to its products.

Service and Support

A service routine has to be done on your MAXI500 floor lift by ArjoHuntleigh trained service personnel. This will ensure it remains safe and functional.

Please contact your local ArjoHuntleigh vendor for any of the following:

- If you require further information.
- Want to report an unexpected event, change in the performance or a malfunction.
- Need any help in setting up, using or maintaining your MAXI500.
- Need replacement parts.

Your ArjoHuntleigh vendor can offer support and service programs to maximize the long-term safety, reliability and value of the product.

Manufacturer Information

This product was manufactured by:

ArjoHuntleigh AB
Verkstadsvägen 5
241 38 Eslöv
SWEDEN

☎: +46 (0) 10-335 45 00

☎: +46 (0) 413-138 76

🌐: www.ArjoHuntleigh.com

Definitions Used in this Manual

WARNING:

Means: Failure to understand and follow this instruction may result in injury to yourself and others.

CAUTION:

Means: Failure to follow this instruction may cause damage to the product(s).

NOTE:

Means: Important information regarding correct use of the product.

Safety Instructions

The *MAXI500* floor lift must always be handled by a trained caregiver, as per instructions herein, who shall attend to the patient during lift operation.

Intended Use

The *MAXI500* floor lift has been designed to assist caregivers in homecare environments, hospitals, nursing homes or other assisted living centres. It is intended for lifting patients with reduced mobility for the following purposes:

- Transferring to or from adjacent location, such as chair, wheelchair, bed, bath, toilet, floor or stretcher.
- Assisting patient with tasks such as, toileting.

WARNING: This product is not intended to be operated by the patient.

Patient could get stuck in many circumstances.

WARNING: The *MAXI500* floor lift must be solely used for the purposes stated above.

Do not use the lift for any other purpose, it could compromise product's reliability and/or patient's safety.

Operational Life

The *MAXI500* floor lift has been designed and tested to achieve up to 10 000 cycles with a load of 227 kg (500 lb).

It is subject to maintenance as specified in the "Care and Maintenance" section in this manual.

The following table shows number of years in relation to cycles per day. One cycle is defined as transferring a 227 kg (500 lb) patient including a raising action, a lateral displacement and a descending action.

| Cycles per Day | Years (10,000 transfers) |
|----------------|-----------------------------|
| 4 | 7 |
| 6 | 4.5 |
| 8 | 3.5 |

WARNING: Using a floor lift or an accessory beyond its life span may result in an incident causing serious injuries.

The life span is the safe operating time period before a complete overhaul is required.

Following are factors that have an impact on the lift's life span:

- aging of the unit;
- transfers per day;
- weight of the patient;
- maintenance frequency.

The expected life for other consumable items, such as batteries, fuses, slings, straps and cords is dependent upon the care and usage of the product. Consumable must be maintained in accordance with published *Instructions for Use* and "Preventive Maintenance Schedule".

Important Safety Instructions

- Before using the *MAXI500*, a clinical assessment of the patient's suitability for transfer must be carried out by a qualified health professional considering that, among other things, the transfer may induce substantial pressure on the patient's body.
- Keep this manual at proximity from the lift and refer to it as required. Make sure that all users are regularly trained in the use of the *MAXI500* floor lift as per the information found therein.
- All controls and safety features are used only as per the rules specified in this manual. Never attempt to force a control or button on the lift.

WARNING: Do not put fingers, hands or feet where space is limited (see "Fig. 1"). This could pinch, cut, or seriously harm body parts.

- Avoid any impact during transfer.

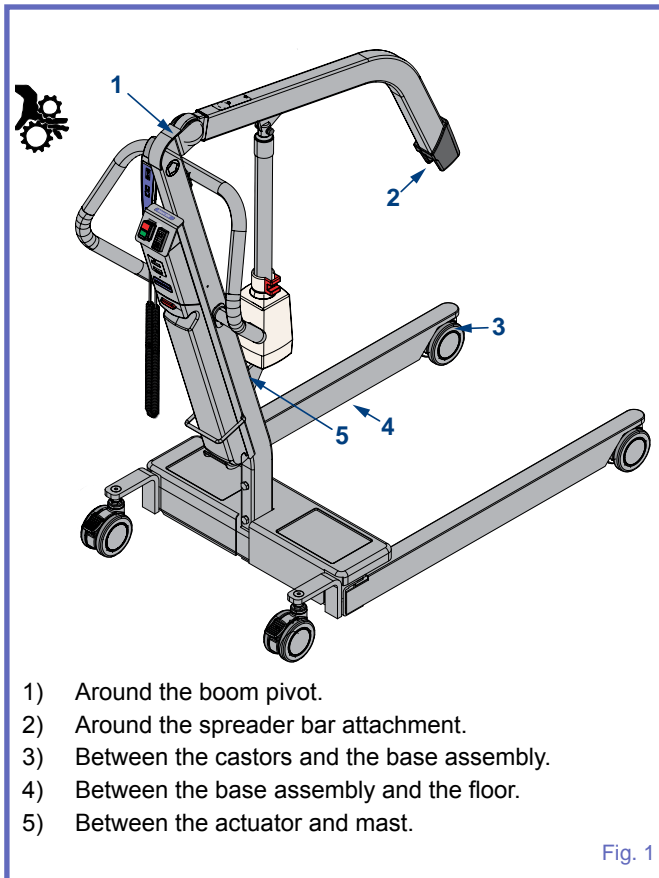

- 1) Around the boom pivot.
- 2) Around the spreader bar attachment.
- 3) Between the castors and the base assembly.
- 4) Between the base assembly and the floor.
- 5) Between the actuator and mast.

Fig. 1

WARNING: ArjoHuntleigh warns of possible strangulation risks related to the hand control cable.

WARNING: Some plastic parts hiding screw heads on the lift may represent a choking hazard for young children. Make sure to replace them if they become loose or damaged.

CAUTION: Do not drop either the lift or the battery pack, as it may cause internal damage that is not easily seen. If the lift is suspected to be damaged, contact your local ArjoHuntleigh vendor for servicing.

CAUTION: Using the *MAXI500* in humid, salty, or chlorinated conditions may cause premature wear of the lift.
In such cases, we recommend to perform a proactive maintenance program with more frequent inspections.

Policy on Number of Staff Members Required for Patient Transfer

ArjoHuntleigh’s floor lifts are designed for safe usage with one caregiver. There are circumstances that may dictate the need for a two-person transfer. It is the responsibility of the caregiver to determine if a one or two person transfer is more appropriate, based on the following:

- resident’s condition (combateness; obesity, contracture etc.);
- the task;
- resident’s weight;
- environment;
- capability;
- skill level of the caregiver.

Do not hesitate to contact your medical professional for guidance.

Safe Working Load (SWL)

The *MAXI500* floor lift has been made for a maximum lifting capacity of 227 kg (500 lb) .

Do not attempt to lift more than the lowest weight limit indicated on the following:

- the “maximum load” label on the lift;
- on the spreader bar;
- on the accessories;
- on the sling.

Battery and Battery Charger Safety Practices

WARNING: Following the instructions is important for the safe use of the battery and to keep the user (resident/caregiver) from harm.

Make sure the battery belongs to the device by comparing the battery label with the “Technical Specifications” section on page 28. If battery type cannot be confirmed, call your vendor for assistance.

CAUTION: Do not expose the battery connectors or the battery charger to water. Humid air or water can cause premature wear to the battery or the charger.

- Only use the charger that has been supplied with the equipment.
- Do not charge the batteries in an unventilated area.
- The charger must not be covered or exposed to dust.
- Do not crush, puncture, open, dismantle or otherwise mechanically interfere with the batteries.
- Do not store the battery at a temperature higher than 40°C (104°F).
- Stop using the battery if any damage or deformation is noted.

Shock Prevention

- Electrically live equipment can result in serious injuries. If the lift or charger has any exposed or damaged wires, contact your local ArjoHuntleigh vendor immediately.
- Do not attempt to expose, service or repair the lift, battery or charger. If any unit is malfunctioning, contact your local ArjoHuntleigh vendor.

Fire and Explosion Prevention

- Do not place or store the battery under direct sunlight or near a heat source.
- Do not expose the batteries or battery charger to flames.
- Do not use the charger in the presence of flammable anaesthetic gases.
- Do not short circuit the battery terminals.

Human and Environmental Safety Practices

- Should the battery casing crack, allowing its contents to come into contact with skin or clothing, rinse immediately with water. If the contents comes in contact with the eyes, rinse immediately with plenty of water and seek medical attention.
- Inhalation of the contents can cause respiratory irritation. Seek out fresh air and medical attention.
- For recycling and disposal of the batteries, the rules according to the WEEE directive (Waste of Electronic and Electrical Equipment) as well as local laws and regulations must be followed. When returning batteries, insulate their terminals with adhesive tape. Otherwise, the residual electricity in used batteries may cause fire or explosion.

In case of doubt about the way to proceed, please contact your local authorities to determine the proper method of disposal.















Homecare Environment Considerations

WARNING: The *MAXI500* is not intended to be operated by children. Serious injuries could occur.

NOTE: Cleaning actions should be done rigorously when the *MAXI500* is exposed to an animal.

Pet hair trapped around mobile parts can affect lift's performance.

General Symbols

| | |
|---|--|
|  | This symbol points out the manufacturer's name and address. May also point out manufacturing date. |
|  | This symbol means that the product complies with the medical device directive 93/42/EEC. |
|  | This symbol points out the manufacturer's catalogue number. |
|  | This symbol points out the manufacturer's serial number. |
|  | "Separate collection" for all batteries and accumulators as per the WEEE Directive. |
|  | This symbol means that the item can be recycled. |
|  | This symbol means that you must refer to the Instructions for Use (IFU). |
|  | This symbol points out a Type BF applied part. |
|  | This symbol points out a Type B applied part. |
|  | This symbols points out a risk of pinching. |
| SWL | SWL is the maximum load the device is rated for safe usage. |
|  | This symbol points out the emergency stop device. |
|  | This symbol points out the reset switch. |
|  | Correct. |
|  | Incorrect. |

Charger Related

| | |
|---|---|
|  | Class II electrical equipment. This term refers to electrical equipment in which protection against electric shock does not rely on basic insulation only. |
|---|---|

When applicable, symbol reference can be found in EN 60601-1 and WEEE Directive.

Acronyms

| | |
|-----|----------------------------|
| DPS | Dynamic Positioning System |
|-----|----------------------------|

Product Description

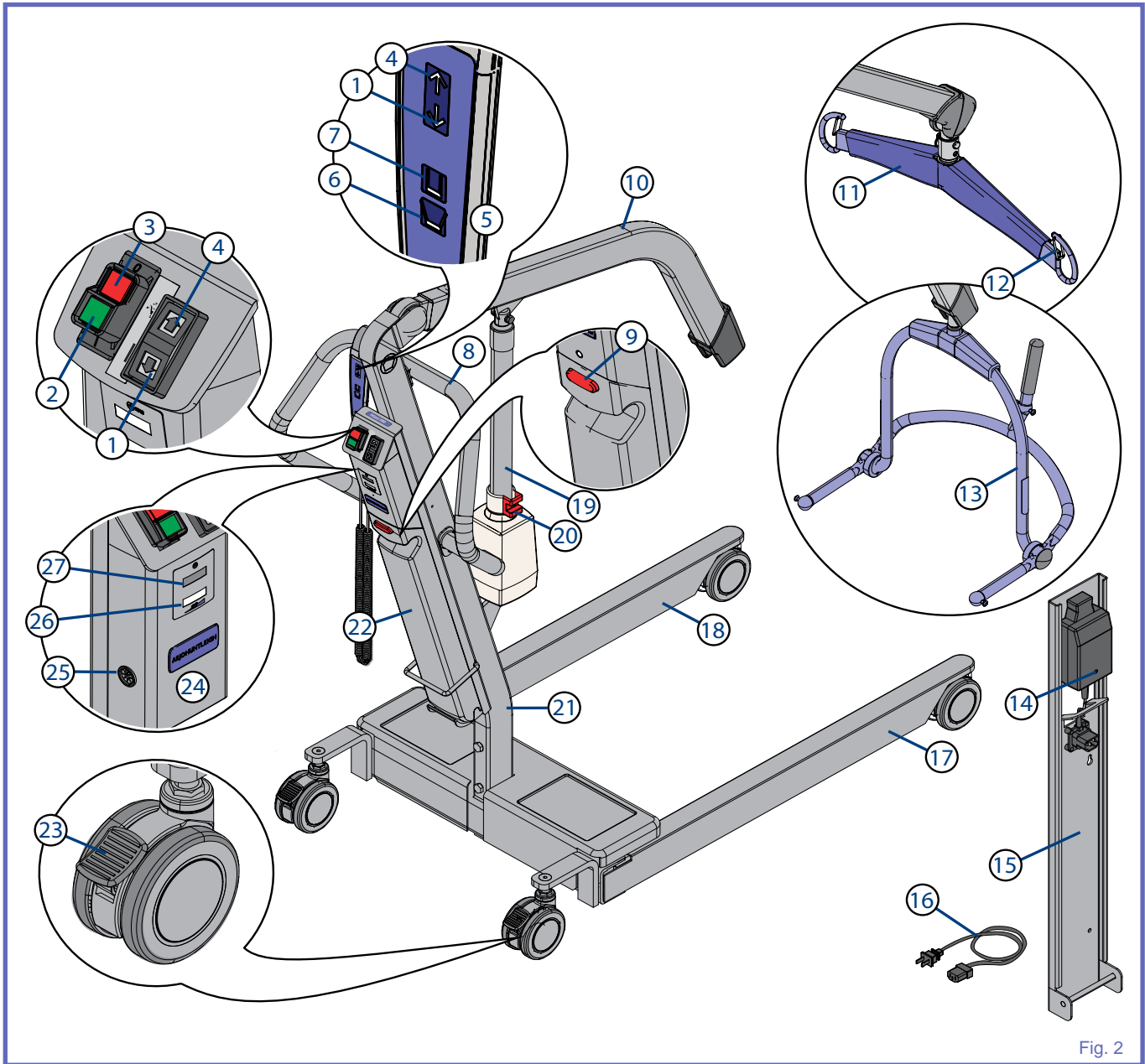

Fig. 2

Legend

- | | |
|---------------------------|-------------------------------|
| 1) Down Button | 14) Charger Status LED |
| 2) Reset Button | 15) Wall-Mounted Charger |
| 3) Emergency Stop Button | 16) Charger Power Cord |
| 4) Up Button | 17) Right Leg |
| 5) Hand Control | 18) Left Leg |
| 6) Leg Opening Button | 19) Actuator |
| 7) Leg Closing Button | 20) Emergency Lowering Handle |
| 8) Handle | 21) Mast |
| 9) Battery Release Button | 22) Battery Pack |
| 10) Boom | 23) Castor Break |
| 11) 2-Point Spreader Bar | 24) Control Box |
| 12) Safety Latch | 25) Hand Control Connector |
| 13) DPS Spreader Bar | 26) Battery Status Display |
| | 27) Hour Meter |

How to use the *MAXI500*

Adjusting Legs Spreading

The legs' opening width can be adjusted by using the two bottom buttons on the hand control.

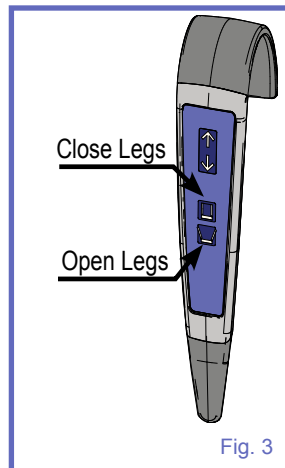

Fig. 3

Brakes

Foot operated brakes are fitted on both rear castors.

To apply brakes, step on the back portion of pad.

To release brakes, push the top portion of the pad forward.

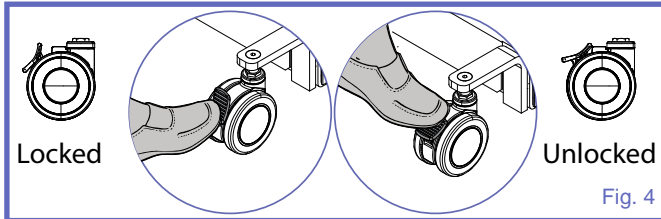

Fig. 4

Emergency Stop

The operator can shut off the power at any time by pressing the red emergency button on the control panel or by pressing the red button on the battery while pulling it backward to remove it.

Reset the emergency stop function by pressing on the green power button or by replacing the battery.

First-time users should practice the emergency stop manoeuvre before operating the lift with a patient in it.

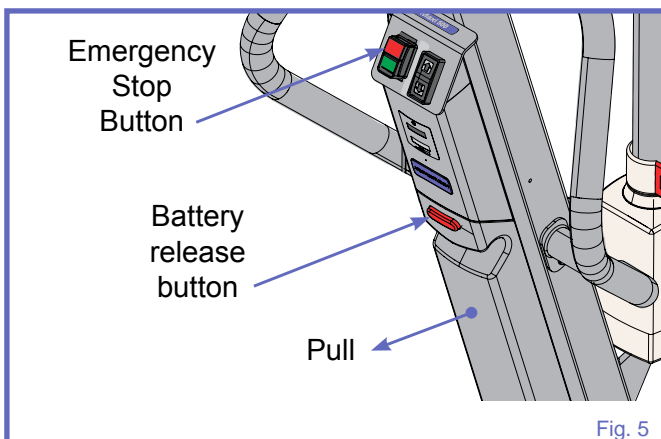

Fig. 5

Boom Control

The electrical actuator can be operated in both directions. It allows the operator to raise or lower the patient without any physical effort. The boom raising/lowering action is controlled by the "Up"/"Down" buttons located on the control box and on the hand control.

If two buttons are pressed simultaneously, the first function button pressed overrides the other function until it is released.

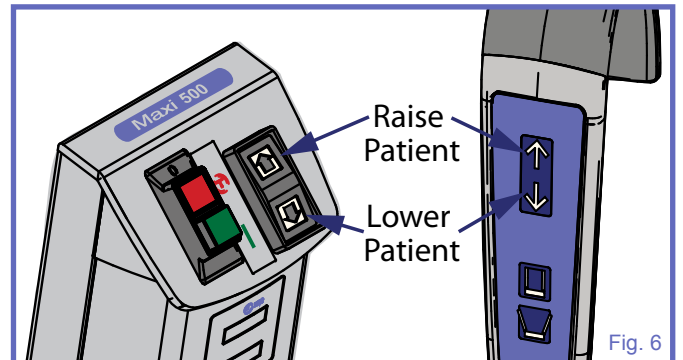

Fig. 6

To Raise the Patient

WARNING: Always make sure that the spreader bar is above the patient before lifting.

Failure to follow this instruction may cause the patient to swing resulting in injury.

The "UP" buttons are used to raise the boom. The boom keeps rising as long as the button is pressed or until it reaches its upper travel limit.

To Lower the Patient

The "Down" buttons are used to lower the boom. The boom keeps lowering as long as the button is pressed or until it reaches its lower travel limit.

Moving the MAXI500

Always use the handles to manoeuvre the lift.

Close the legs and move the lift in the direction of travel as shown in the figure below.

If necessary, initiate the movement by pushing on the back of the base with your foot. Do not push on the legs.

WARNING: Never attempt to manoeuvre the lift by pulling on the mast, boom, actuator or patient. Doing so could cause incidents resulting in injuries.

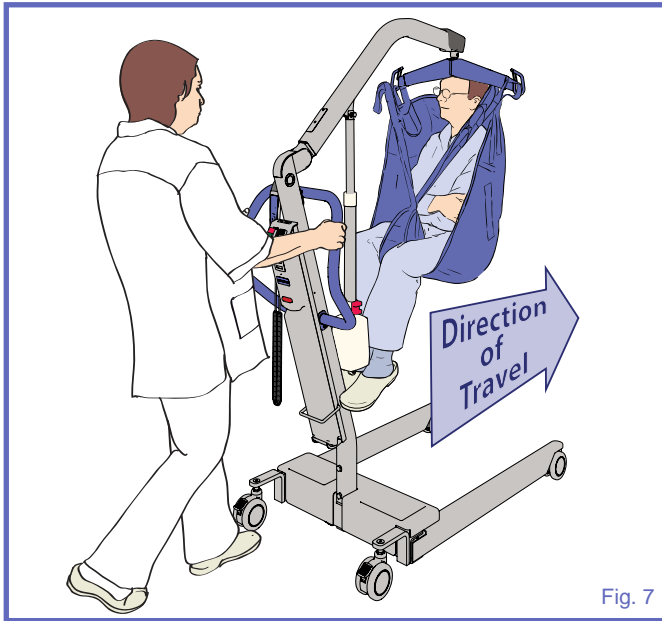

Fig. 7

Never attempt to push or pull a loaded lift over a floor obstruction which the castors are unable to ride over easily, including steps, door thresholds or moving sidewalk.

Do not push the lift at a speed which exceeds a slow walking pace (3 km/hour or 0.8 meter/second).

Emergency Lowering

This feature allows the boom to be lowered in the event of a main control failure.

In the event of a hand control or control box failure, locate the red handle above the actuator.

Gradually pull the handle up and hold it until the actuator is lowered to the desired level. The force exerted on the handle and the patient weight affects the speed of descent.

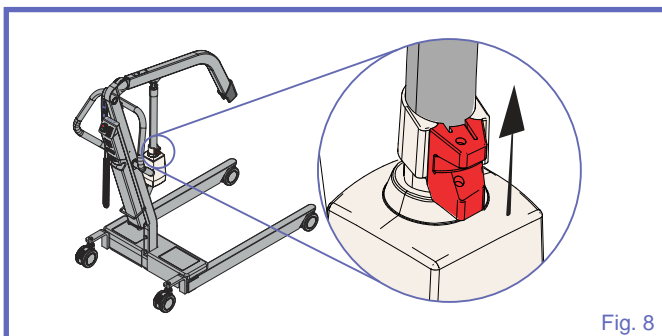

Fig. 8

WARNING: Before operating the “emergency lowering”, always ensure that a suitable support is underneath, ready to receive, the patient.

The handle is spring loaded and will return to normal position and stop the lowering process when released. Note that a load must be applied to the boom for the device to function.

CAUTION: This function should only be used in the event of control failure, and not as a regular lowering function for the equipment.

Automatic Cut-out

During lifting

This feature will stop the lifting motion in the event where the MAXI500 is trying to raise a patient heavier than the SWL.

During lowering

This feature disables the down motion when the boom is being lowered onto the patient or any other obstruction.

Sleep Mode

The control box includes an automatic switch-off control that disables part of the circuitry, after 2 minutes of inactivity, to prevent battery from draining.

Power is re-established when a control button is pressed.

Hour Meter

The hour meter is an LCD display which shows the total duration of powered operation (in hours).

This is primarily intended as an aid for scheduling maintenances.



Fig. 9

Battery Charge Indicator

The battery charge indicator is a bar graph display, located on the battery pack holder, which shows the charge condition of the battery.

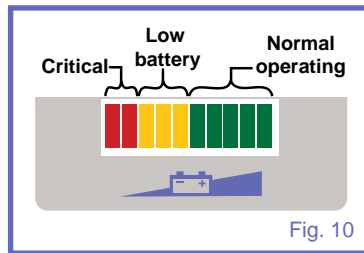

The lift is equipped with an audible warning device, which will beep when the battery level reaches the critical range.

CAUTION: When the indicator reaches the critical range, recharge the battery immediately to prevent reducing its lifespan.

When a fully charged battery is inserted into the lift, the display will return to the green fully charged position, regardless of the level the indicator had reached previously. However, if a partially charged battery is inserted, the previous indicator level will be maintained, even though the recently inserted battery may be in a better state of charge than indicated. To achieve a true indication of battery condition, a fully charged battery must be inserted into the lift.

Battery Information

For safe handling and to extend the battery lifetime, please follow and remember these instructions.

The *MAXI500* uses a 24 volts sealed lead-acid battery pack that can deliver up to 100 lifts per charge.

Battery life is variable (2-3 years) and is influenced by: frequency of use, frequency of charging, temperature of operation/storage and storage time.

To prolong the battery pack life, recharge it before the indicator reaches the Low Battery range.

To ensure that the *MAXI500* is always ready for use, it is recommended that a fully charged battery pack always be available. Do this by having additional battery packs, and keeping one battery pack charging while the other is in use.

Remove the battery pack from the lift when storing for an extended period of time. Stored batteries should be recharged at least every two weeks to maximize their life span.

Battery Charging

The battery should be recharged as soon as the discharge indicator displays amber.

Refer to Battery Charger *IFU* for charging details.

Note that the battery pack may remain connected to the charger when fully charged.

Inserting/Removing the Battery Pack

The same method applies for inserting/removing the battery pack into/from the lift or the charger.

Inserting the Battery Pack

- 1) Align the bottom of the battery pack with the bottom of the battery support.
- 2) Insert the battery pack until it rests into the support base.
- 3) Push the top of the battery until it latches to the support.

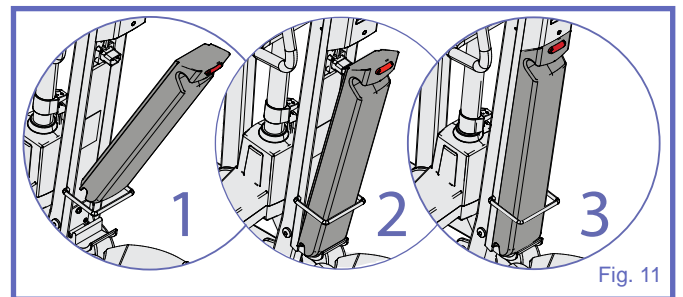

Removing the Battery Pack

- 1) Push the release button.
- 2) Pull the battery back.
- 3) Lift the battery to pull it out of the battery rack.

Model 1000 Scale (optional)

The model 1000 scale is a compact and precise scale system, integrated into the *MAXI500*, that can read up to 227 kg (500 lb). Completely self-contained, the model 1000 scale combines the latest precision strain gauge technology and microprocessor signal conditioning to provide stable, accurate and repeatable weight data, with a calibrated accuracy of 0.1%. One-button Auto Zero Electronics makes patient weighing quick and easy. The MODEL 1000 scale derives its power from a single 9-volts lithium battery.

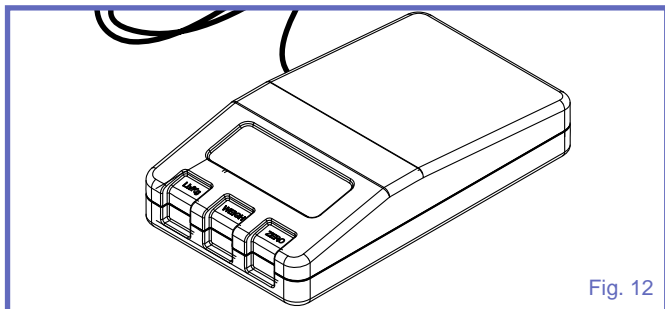

When battery replacement is required, an indicator will show on the display. Simply remove the four screws on the bottom of the case and remove the top casing to access the battery.

CAUTION: The load cell contains no user serviceable components and should be serviced by authorized personnel only. Any unauthorized tampering will void the warranty.

Using the Model 1000 Scale

- 1) Ensure the patient is suspended free and clear of any obstructions, e.g. bed, chair, floor, etc. Ensure that no part of the patient is in contact with the mast or boom during weighing, as the jib and spreader bar are integral parts of the weighing equipment.
- 2) With agitated patient the attendant should wait until the patient is calm before attempting to weigh.
- 3) Do not touch or lean on the patient, boom, or spreader bar during the weighing operation.
- 4) The patient has to be centered in the sling, sitting in an upright position, facing the mast or positioned so that the mast is behind his/her back.

Clip Slings Application

Clip Sling Compatibility

This section only applies for model supplied with the DPS spreader bar.

Following is a list of typical ArjoHuntleigh clip slings that are compatible with the *MAXI500* floor lift.

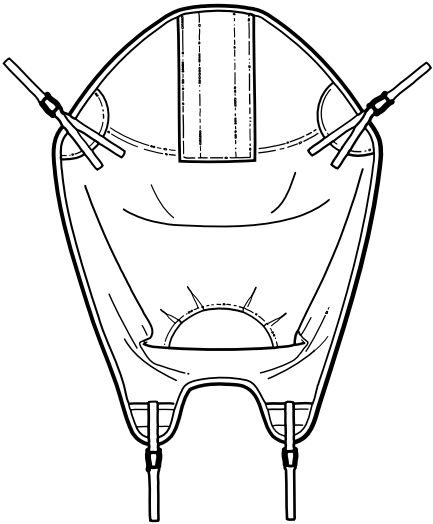

MAA2090-XX
Four-Point Amputee

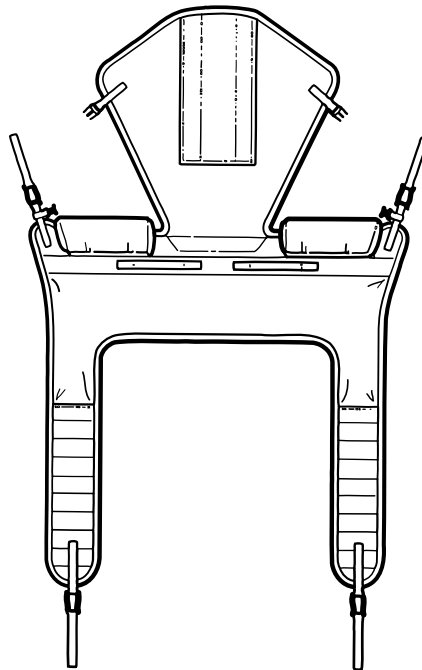

MAA4031-XX
Four-Point Hygienic

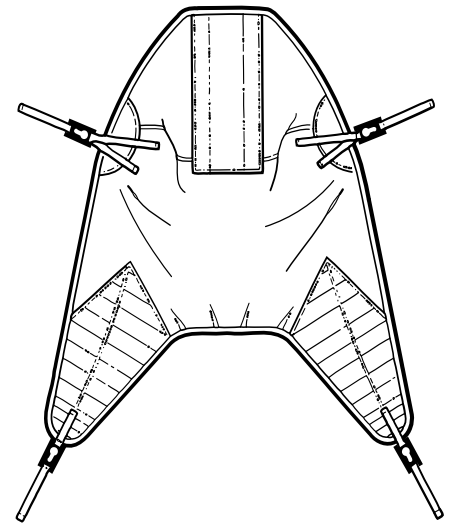

MAA4000-XX
Four-Pointed Padded

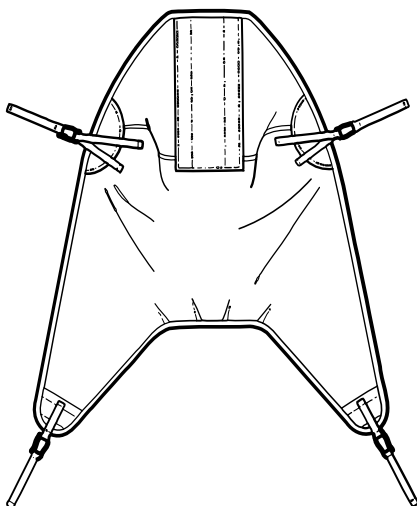

MAA-2000-XX
Four Point Non-padded

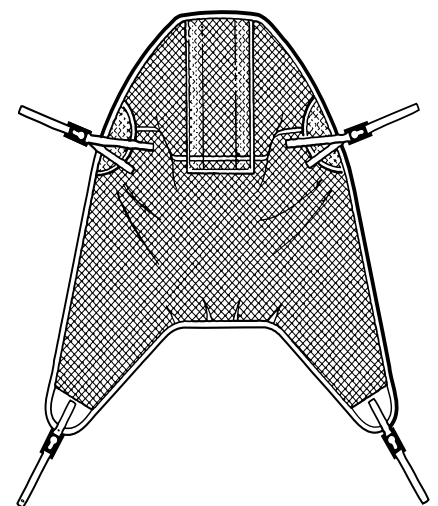

MAA4060-XX
Four-Pointed Mesh

NOTE: Other sling models are available. Contact your ArjoHuntleigh vendor for more information about clip slings and how to use them.

Sling Selection

The spreader bar that is attached to the lift determines what slings can be used to transfer a patient.

Slings are colour coded for size by having a different colour edge binding or attachment strap colouring:

- Teal - Extra Extra Small - XXS
- Brown - Extra Small - XS
- Red - Small - S
- Yellow - Medium - M
- Green - Large - L
- Purple - Large Large - LL
- Blue - Extra Large - XL
- Terracotta - Extra Extra Large - XXL

Note that some sling models are not available in all sizes.

A wide variety of slings are available for each application. Please contact your local ArjoHuntleigh vendor for more information.

Flites® (single patient multi-use slings) are also available for most sling models. If ArjoHuntleigh *Flites* slings are to be used with the *MAXI500* floor lift, refer to the separate ArjoHuntleigh *Flites* slings *Instruction for Use*.

Spreader Bar Compatibility

The *MAXI500* floor lift is only compatible with the spreader bar that is delivered with the lift.

MAXI500 floor lift model that is designed for use with clip slings is delivered with a manual DPS spreader bar.

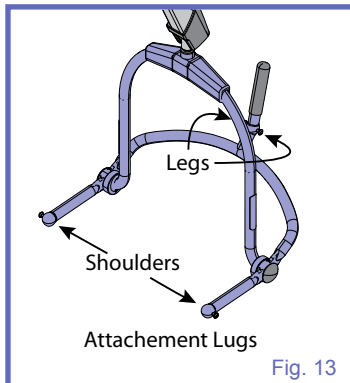

WARNING: Using the DPS with amputee sling may cause injuries if not used correctly.

Attaching the Sling to the DPS

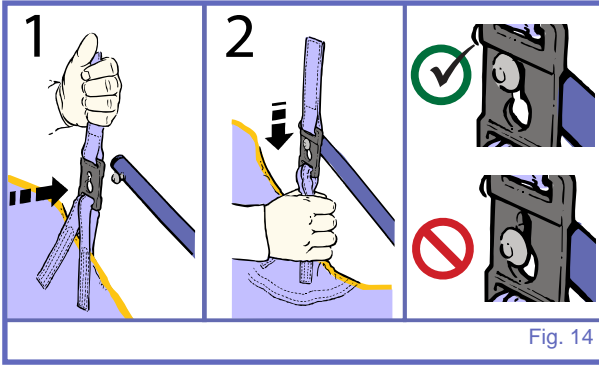

Insert the clip attachment over the lug on the DPS. Secure the clip in place by pulling the sling down so that the lug is in the top portion of the clip hole.

WARNING: Make sure all clips are correctly engaged. Failure to do so could result in patient fall.

Method 1 - Straight Attachment

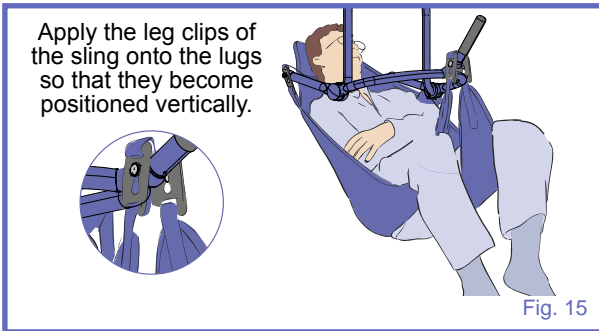

For most patients, the straight attachment of the leg clips is recommended.

Method 2 - Crossed Legs Attachment

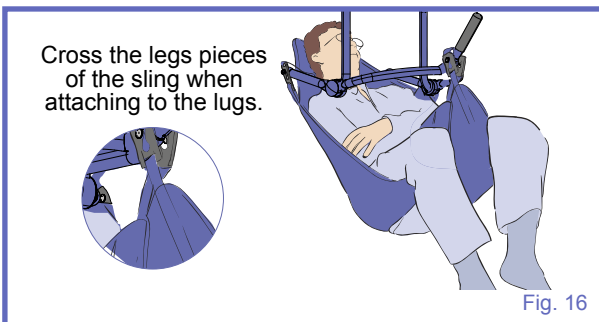

If the patient is prone to kicking off the leg clip, the crossed attachment of the leg clips shall be applied, which will prohibit the clip from being kicked off.

Detaching the Sling from the DPS

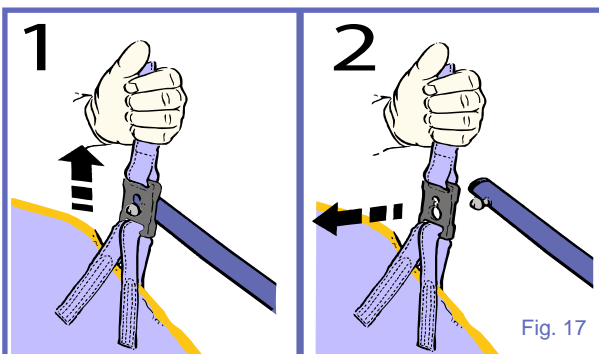

Pull the sling up to release the lock.

Remove the clip attachment from the lug on the DPS.

Operating the DPS

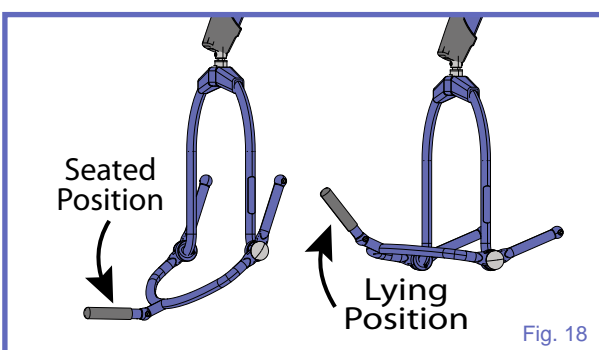

Note: To ensure maximum patient comfort, do not allow them to hold onto the spreader bar.

The DPS spreader bar is adjusted by rising or lowering the tilt handle until the patient is in the desired position.

Transferring Patients Using Clip Slings

Before using the MAXI500 ensure that:

- A clinical assessment of the patient's suitability for transfer is carried out by a qualified health professional considering that, among other things, the transfer may induce substantial pressure on the patient's body.
- Special consideration is taken when transferring a patient who is connected to electrodes, catheters, or other medical devices.
- Always carry out the items marked as "Before every use" in the "Preventive Maintenance Schedule" before using the lift.

WARNING: Always hold the spreader bar when near a patient. The spreader bar could hit the patient resulting in injury.

WARNING: To avoid injury or discomfort, do not lower the spreader bar onto the patient.

WARNING: Before raising the patient, always make sure the sling is not caught on any obstructions (for instance, the wheelchair brakes or armrests). Sling catching in such obstructions could result in patient fall.

WARNING: Always confirm that the sling clips remain attached as the weight of the patient is gradually taken up. A wrongly clipped attachment could detach resulting in patient fall.

Lifting Patient from a Seated Position

- 1) Place the sling around the patient so that the base of the sling sits slightly below the tail bone.
A MaxiSlide® or MaxiTube® positioning aid can be used to assist with placement of the sling.



Fig. 19

- 2) Ensure that the head support area of the sling is behind the head covering it.

- 3) Pull each leg strap under the thigh so that it emerges on the inside of the thigh.

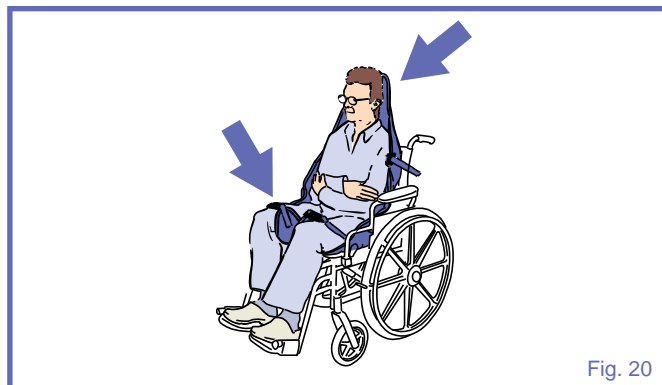

Fig. 20

- 4) Approach the patient with the lift, ensure that:
 - The spreader bar is in sitting position.
 - The wide part of the spreader bar is at or just below shoulder level.
 - The spreader bar is close enough to be able to connect the shoulder strap clips of the sling to the frame.
- 5) Connect the shoulder strap clips, then tilt the frame and attach the leg sections. If necessary, lower the spreader bar a little further, being careful not to lower it onto the patient.



Fig. 21

- 6) Raise the patient using the hand control, positioning him comfortably to a semi-reclined position for the transfer. The patient should not be lifted above the caregiver's eye level.
- 7) Turn the patient to face the caregiver, and keep at a normal chair height.
- 8) Proceed with the transfer.

Lowering Patient to a Seated Position

- 1) Once the patient has arrived at destination, reposition the patient according to the destination position.
- 2) Lower the patient down onto the new location by making small adjustments during the descent.
- 3) When the patient's body weight is fully supported, detach the connections clips.
- 4) Move the lift away from the patient.
- 5) Remove the sling from under the patient.

Lifting Patient from a Bed

Before you start, make sure the bed is in correct working height.

WARNING: Make sure that the bed safety side is installed to prevent the patient from falling.

- 1) Roll the patient onto their side.
- 2) Fold the sling in half and place on the bed land marking it, along the back of the patient so that the base of his spine is aligned with the base of the sling, making sure the sling extends to the top of the patient's head.



- 3) Roll the patient back onto the sling and then slightly further in the opposite direction, so that the folded part of the sling can be unfolded.

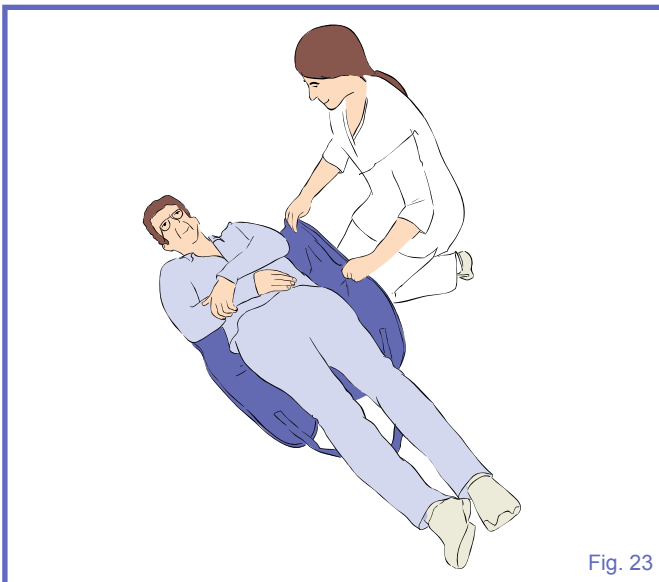

- 4) If possible, slightly raise the head of the bed.
- 5) Approach the patient with the lift, and ensure that:
 - the spreader bar is in reclined position;
 - the spreader bar is close enough to be able to connect the shoulder strap clips of the sling to the frame.

- 6) Using the hand control, lower the spreader bar taking care not to lower the frame onto the patient.
- 7) Connect the sling shoulder and leg strap clips to the spreader bar.

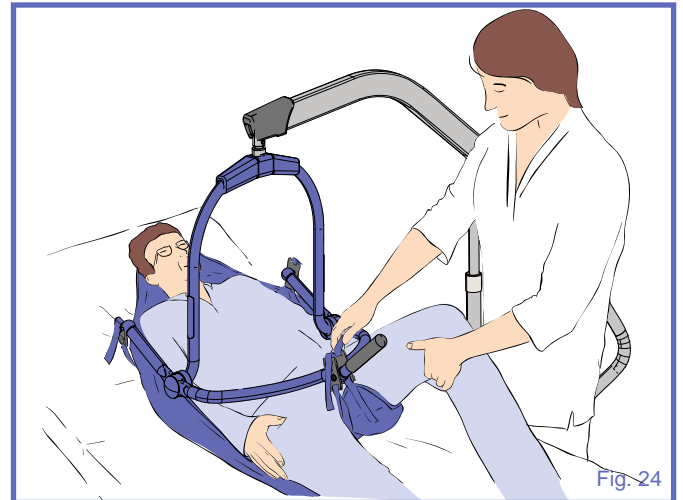

- 8) Raise the patient using the hand control, positioning him comfortably to a semi-reclined position for the transfer. The patient should not be lifted above the caregiver's eye-level.
- 9) Turn the patient to face the caregiver, and keep at a normal chair height.
- 10) Proceed with the transfer.

Lowering Patient to a Bed

- 1) Once the patient has arrived at destination reposition the patient according to the destination position.
- 2) Lower the patient down onto the new location by making small adjustments during the descent so that the patient is always in the best comfortable position.
- 3) When the patient's body weight is fully supported, detach the connections clips.
- 4) Move the lift away from the patient.
- 5) Remove the sling from under the patient.

Lifting Patient from the Floor

The technique described here can be used for transferring patients lying on the floor.

Patients being lifted from the floor due to a slip or fall should only be lifted after examination by qualified medical personnel. The patient can be lifted from a completely reclined position on the floor, but for his comfort, put a pillow under his head first.

- 1) Roll the patient onto their side.
- 2) Fold the sling in half and place on the floor land marking it, along the back of the patient so that the base of his spine is aligned with the base of the sling, making sure the sling extends to the top of the patient's head.



- 3) Roll the patient back onto the sling and then slightly further in the opposite direction, so that the folded part of the sling can be unfolded.

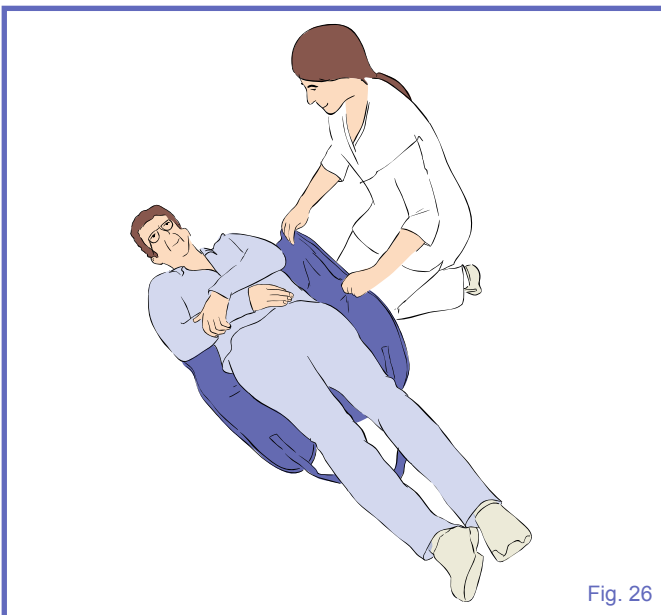

- 4) Depending on circumstances, space or position of patient, approach the patient with the open part of the chassis.
- 5) Adjustment of the spreader bar height may have to be made before connection is possible.

- 6) Attach the shoulder strap clips first, then, with the open part of the sling, support frame pointing downwards towards the shoulders, connect the leg strap clips.



- 7) When all the clips are securely attached, raise the patient from the floor in a semi-recumbent position.
- 8) Once raised from the floor, ensure the patient's legs are clear of the chassis before continuing to lift.
- 9) Turn the patient to face the caregiver, and keep at a normal chair height.
- 10) Proceed with the transfer.

Lowering Patient to the Floor

- 1) Lower the patient down onto the new location by making small adjustments during the descent so that the patient is always in the best comfortable position.
- 2) When the patient's body weight is fully supported, detach the connections clips.
- 3) Move the lift away from the patient.
- 4) Remove the sling from under the patient.

Loop Slings Application

Compatible Loop Slings

This section only applies for lifts supplied with a 2-point spreader bar.
ArjoHuntleigh loop sling profiles that can be used with the *MAXI500*.

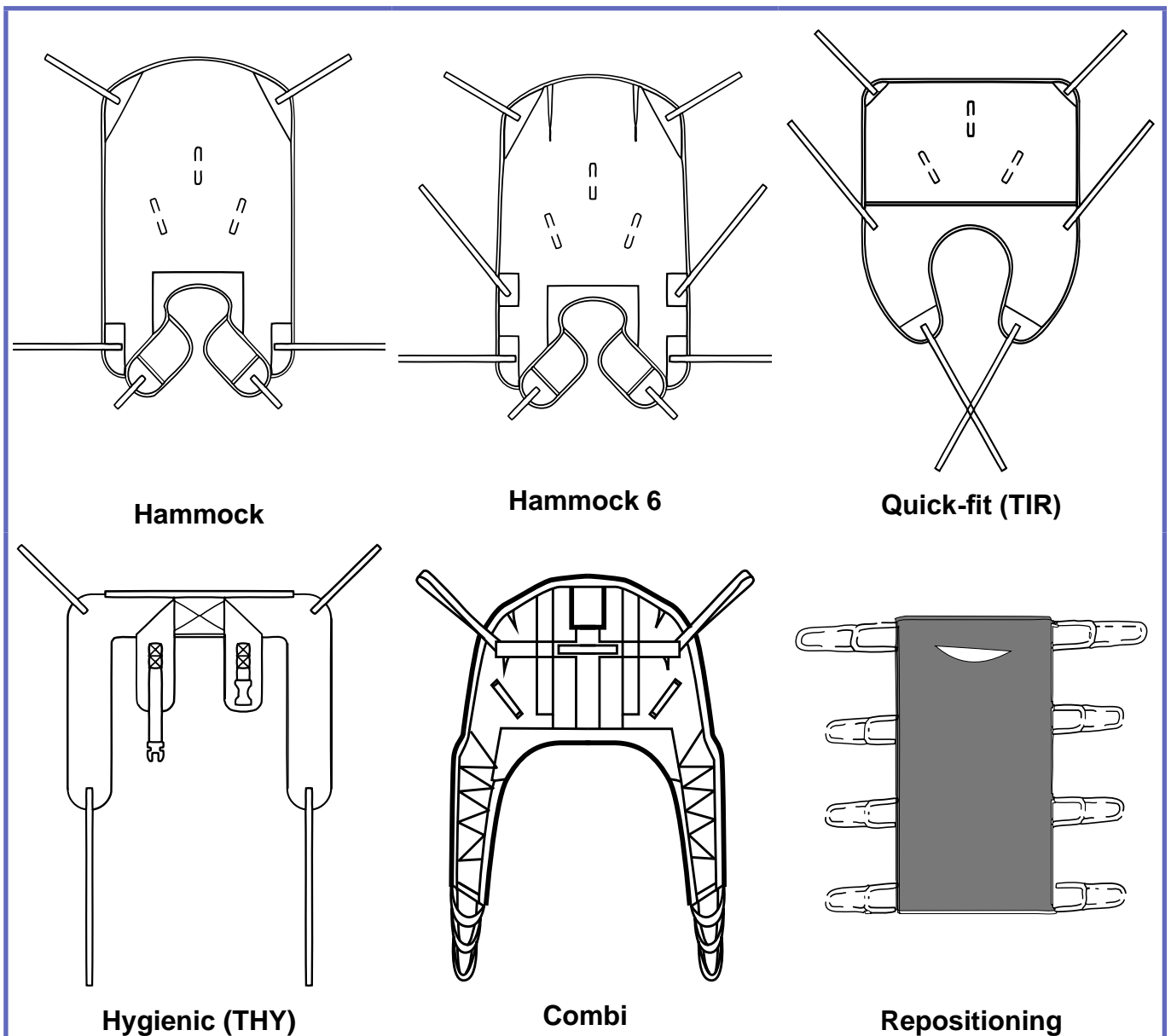

NOTE: Other sling models are available. Contact your ArjoHuntleigh vendor for more information about loop slings and how to use them.

Sling Selection

The spreader bar that is attached to the lift determines what slings can be used to transfer a patient.

Slings are colour coded for size by having a different colour edge binding or attachment strap colouring:

- Red - Small - S
- Yellow - Medium - M
- Green - Large - L
- Blue - Extra Large - XL

Note that some sling models are not available in all sizes.

A wide variety of slings are available for each application. Please contact your local ArjoHuntleigh vendor for more information.

Flites® (single patient multi-use slings) are also available for most sling models. If ArjoHuntleigh *Flites* slings are to be used with the *MAXI500* floor lift, refer to the separate ArjoHuntleigh *Flites* slings *Instruction for Use*.

WARNING: Only use ArjoHuntleigh slings with the *MAXI500* floor lift. Use of non-approved slings could result in patient fall.

Spreader Bar Compatibility

The *MAXI500* floor lift is only compatible with the spreader bar that is delivered with the lift.

MAXI500 floor lift model that is designed for use with loop slings is delivered with a 2-point spreader bar.

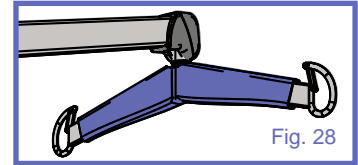

Fig. 28

Attaching the Sling to the Spreader Bar

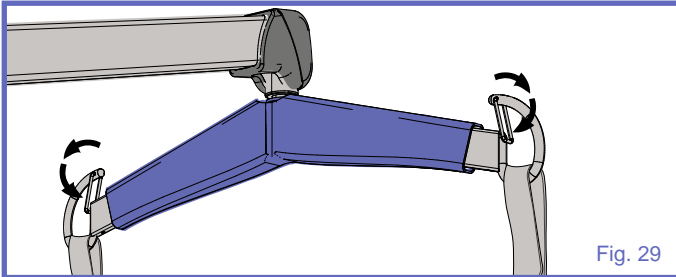

Fig. 29

Place the attachment loops onto the hooks. Make sure the loops are positioned correctly and that the safety latches are closing the hooks as shown in “Fig. 29”.

Positioning the Patient

Loop slings are available in many sizes. The correct size sling will be able to support the patient’s shoulders during the transferring procedure.

The specific loop sling chosen determine the position of the patient. Different loop combinations can be used to allow the patient to be lifted and transferred in positions ranging from semi-reclined to seated.

NOTE: Slings with more loops allow additional alternative positions.

| Body Position According to Selection of Loop Straps | | | |
|---|-----------|------|-------|
| SHOULDERS | SHOULDERS | LEGS | HIPS* |
| LEGS | | | |
| | 3 | 1 | 1 |
| | 2 | 1 | 1 |
| | 1 | 1 | 1 |
| | 1 | 1 | 2 |

*Hip loops only available on THA6i model

Attachment Methods

Once the loop sling has been fitted around the patient, it can be configured in three ways. With each of the three methods described below, it is necessary to first connect each shoulder loop of the sling to both sides of the spreader bar.

Attachments Points

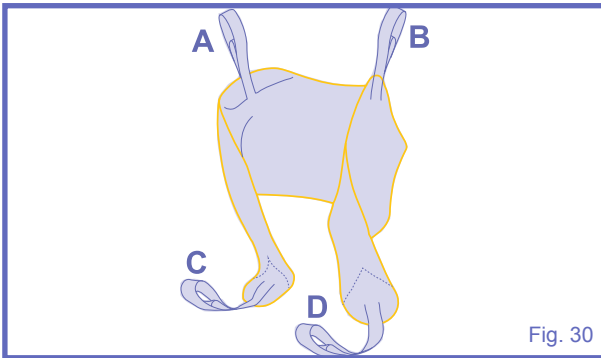

The attachment point designation shown here are only for the purpose of the explanations below.

Method 1 - Cross-through

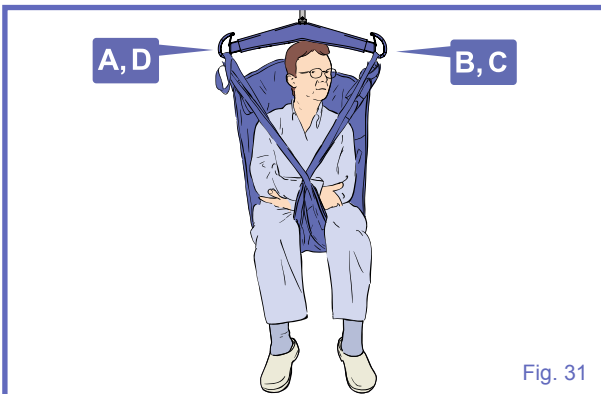

This method is recommended for most general transfer

Legs closed with crossing straps

Method 2 - Hammock

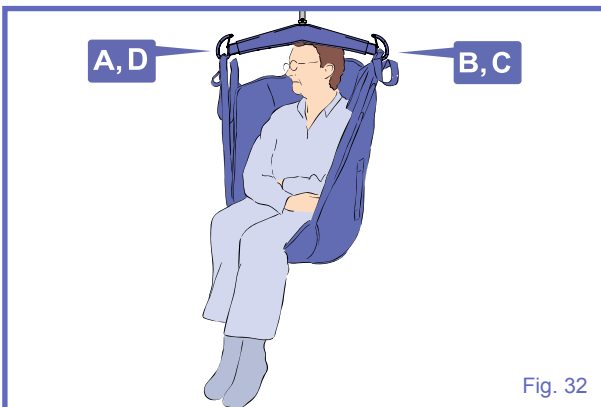

This method can provide a comfortable cradle for amputee patient.

It is also a useful method for patients with contractures, making it difficult to bring a sling strap between the legs.

WARNING: Method 2 might not be suitable for confused, combative or erratic patients as they can fall forward and get injured.

Bridge, legs closed

Method 3 - Abduction

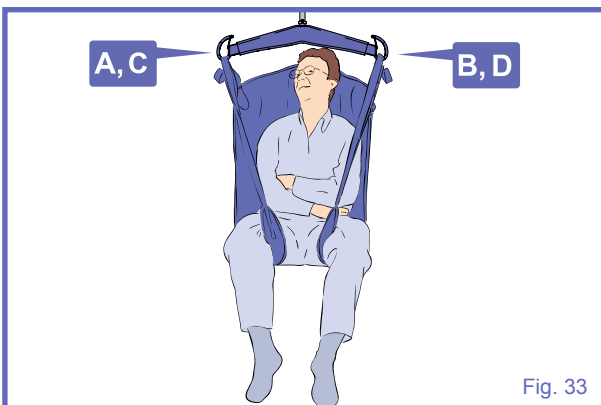

In this method, legs are held in abduction which is convenient for toileting and hygiene care.

WARNING: Method 3 might not be suitable for patients with no upper body control as they can slide down and almost out of the sling.

Legs opened with non-crossing straps

Transferring Patients Using Loop Slings

Before using the *MAXI500* ensure that:

- A clinical assessment of the patient's suitability for transfer is carried out by a qualified health professional considering that, among other things, the transfer may induce substantial pressure on the patient's body.
- Special consideration is taken when transferring a patient who is connected to electrodes, catheters, or other medical devices.
- Always carry out the items marked as "Before every use" in the "Preventive Maintenance Schedule" before using the lift.

WARNING: To avoid injury or discomfort, do not lower the spreader bar onto the patient.

WARNING: Always hold the spreader bar when near a patient. The spreader bar could hit the patient resulting in injury.

WARNING: Make sure the sling is not caught on any obstructions (for instance, the wheelchair brakes or armrests). Sling catching in such obstructions could result in patient fall.

Lifting Patient from a Seated Position

The techniques described here can be used for transferring patients regardless of where they may be seated (e.g. in a bed, in a chair, wheelchair or similar).

- 1) Place the sling around the patient so that the base of the sling sits slightly below the tail bone.
A MaxiSlide® or MaxiTube® positioning aid can be used to assist with placement of the sling.



Fig. 34

- 2) Ensure that the head support area of the sling is behind the head covering it.
- 3) Pull each leg strap under the thigh so that it emerges on the inside of the thigh.

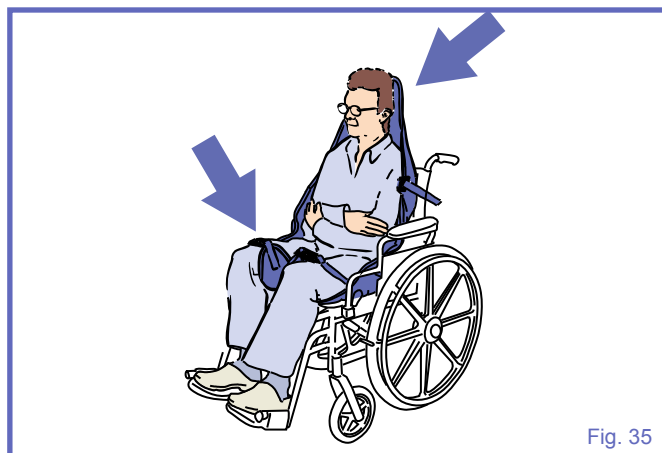

Fig. 35

- 4) Approach the patient with the lift, ensure that:
 - the spreader bar is at or just below shoulder level;
 - the spreader bar is close enough to be able to fix all the sling loops onto the spreader bar hooks.
- 5) Connect the shoulder loops, and then the leg section using one of the three methods previously described.
- 6) If necessary, lower the spreader bar a little further.

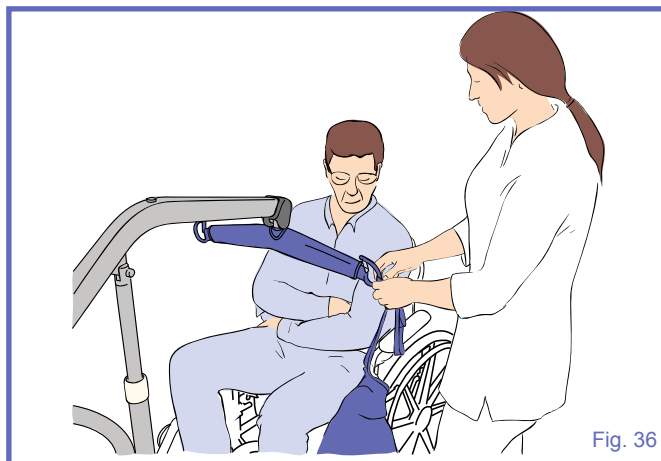

Fig. 36

- 7) Raise the patient using the hand control, positioning him comfortably to a semi-reclined position for the transfer. The patient should not be lifted above the caregiver's eye level.
- 8) Turn the patient to face the caregiver, and keep at a normal chair height.
- 9) Proceed with the transfer.

Lowering Patient to a Seated Position

- 1) Once the patient has arrived at destination, reposition the patient according to the destination position.
- 2) Lower the patient down onto the new location.
- 3) When the patient's body weight is fully supported, detach the sling.
- 4) Move the lift away from the patient.
- 5) Remove the sling from under the patient.

Lifting Patient from a Bed

Before you start, make sure the bed is in correct working height.

WARNING: Make sure that the bed safety side is installed to prevent the patient from falling.

- 1) Roll the patient onto their side.
- 2) Fold the sling in half and place on the bed land marking it, along the back of the patient so that the base of his spine is aligned with the base of the sling, making sure the sling extends to the top of the patient's head.



- 3) Roll the patient back onto the sling and then slightly further in the opposite direction, so that the folded part of the sling can be unfolded.

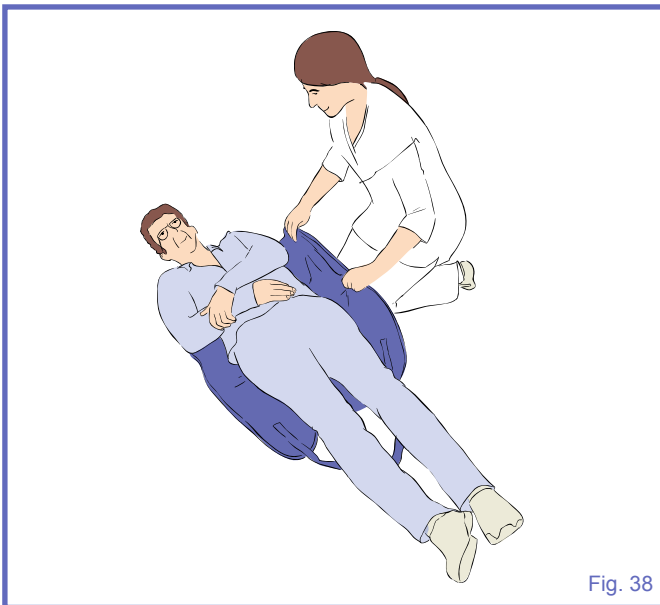

- 4) If possible, slightly raise the head of the bed.
- 5) Approach the patient with the lift. Ensure that the spreader bar is close enough to be able to fix all the sling loops onto the spreader bar hooks.

WARNING: Always hold the spreader bar when near a patient. The spreader bar could hit the patient resulting in injury.

- 6) Connect the shoulder loops, and then the leg section using one of the three methods previously described.

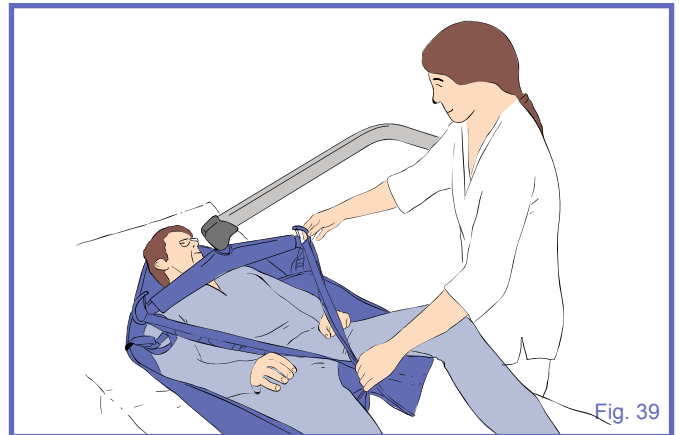

- 7) Raise the patient using the hand control, positioning him comfortably to a semi-reclined position for the transfer. The patient should not be lifted above the caregiver's eye-level.
- 8) Turn the patient to face the caregiver, and keep at a normal chair height.
- 9) Proceed with the transfer.

Lowering Patient to a Bed

- 1) Once the patient has arrived at destination reposition the patient according to the destination position.
- 2) Lower the patient down onto the new location.
- 3) When the patient's body weight is fully supported, detach the sling.
- 4) Move the lift away from the patient.
- 5) Remove the sling from under the patient.

Lifting Patient from the Floor

The technique described here can be used for transferring patients lying on the floor.

Patients being lifted from the floor due to a slip or fall should only be lifted after examination by qualified medical personnel. The patient can be lifted from a completely reclined position on the floor, but for his comfort, put a pillow under his head first.

- 1) Roll the patient onto their side.
- 2) Fold the sling in half and place on the floor land marking it, along the back of the patient so that the base of his spine is aligned with the base of the sling, making sure the sling extends to the top of the patient's head.



- 3) Roll the patient back onto the sling and then slightly further in the opposite direction, so that the folded part of the sling can be unfolded.



- 4) Depending on circumstances, space or position of patient, approach the patient with the open part of the chassis.

- 5) Adjustment of the spreader bar height may have to be made before connection is possible.
- 6) Connect the shoulder loops, and then the leg section using one of the three methods previously described.
- 7) When all the connectors are securely attached, raise the patient from the floor in a semi-recumbent position.
- 8) Once raised from the floor, ensure the patient's legs are clear of the chassis before continuing to lift.

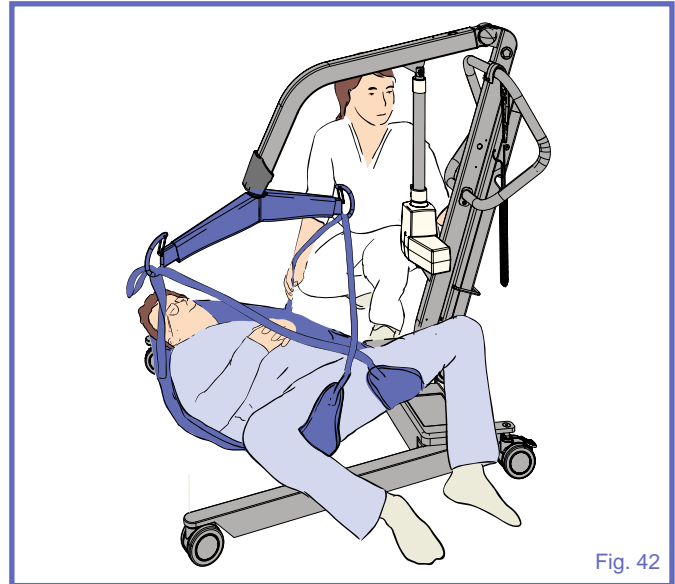

- 9) Turn the patient to face the caregiver, and keep at a normal chair height.

Lowering Patient to the Floor

- 1) Lower the patient down onto the new location.
- 2) When the patient's body weight is fully supported, detach the sling.
- 3) Move the lift away from the patient.
- 4) Remove the sling from under the patient.

Lift Cleaning and Care

Note: It is recommended that your *MAXI500* and its accessories are cleaned and disinfected between each patient use, or daily as a minimum. If the lift and equipment needs cleaning, or is suspected of being contaminated, follow the cleaning and disinfection procedures recommended below, before re-using the equipment.

For cleaning your lift and its accessories wipe down with a damp cloth using warm water to which a disinfectant/cleaner has been added (e.g. “ArjoHuntleigh” - disinfectant/cleaner or equivalent).

CAUTION: Never use a wet cloth on the control box, the battery support or the battery pack as it may cause corrosion on electrical components.

If a hot air dryer is used to dry the lift, the temperature must not exceed 80°C (176°F.) Do not use petroleum based solvents or similar, as this may damage plastic parts.

When cleaning, pay special attention to parts that are most likely to be touched such as:

- the handset;
- the control box;
- the battery pack;
- the lift handle;
- the spreader bar.

Preventive Maintenance Schedule

The *MAXI500* is subject to wear and tear, and the following actions must be performed when specified to ensure that the product remains within its original manufacturing specification.

WARNING: The points on this checklist are the minimum the manufacturer recommends. In some cases more frequent inspections should be carried out. Continuing to use this equipment without conducting regular inspections will seriously compromise the user and resident/patient's safety. Preventive maintenance specified in this manual can prevent accidents.

WARNING: Safety related maintenance and authorized service must be carried out by qualified personnel, fully trained in servicing procedures by ArjoHuntleigh, and equipped with correct tools and proper documentation, including Parts List and Service Manual. Failure to meet these requirements could result in personal injuries and/or unsafe equipment.

| POINTS TO BE INSPECTED BY USER/SERVICE TECHNICIAN | FREQUENCY | | |
|---|----------------------|---|---|
| | Annually (12 Hours*) | | |
| | Before every use | | |
| | Initially | ↓ | ↓ |
| 1) When equipped with a 2-point spreader bar, ensure that the bar safety latches are present and are freely pivoting. | | x | |
| 2) Ensure that the battery charge indicator is within the normal range. | | x | |
| 3) Ensure that the casters are firmly fixed to the chassis. | | | x |
| 4) When equipped with a DPS, make sure that the DPS is properly attached with the pin and that the pin is secured with the locking spring. | | x | |
| 5) Make sure that the mast is secured to the base with the locking screw. | | x | |
| 6) Verify the proper functioning of the rear castor brakes. | x | | x |
| 7) Ensure that the actuator attachments are tightened at both ends. | x | | x |
| 8) Check front and rear castors regularly for hair and debris; clean when necessary. | | | x |
| 9) Press the emergency stop button and make sure that all electrical power is cut off. No action should occur when activating the "Up" or "Down" buttons. Hour meter and battery indicator should also shut down. | x | | x |
| 10) Check all the functions on the hand control. Ensure that the hand control touch pad membrane is intact. | x | | x |
| 11) Check all the functions on the control box. | x | | x |
| 12) Check the function of the emergency lowering device by applying weight to the lift and pulling the red handle on the actuator. | x | | x |

* Time period indicated by the Hour meter.

| ADDITIONAL POINTS TO BE INSPECTED BY SERVICE TECHNICIAN | FREQUENCY | | |
|---|----------------------|---|---|
| | Annually (12 Hours*) | | |
| | Before every use | | |
| | Initially | ↓ | ↓ |
| 13) Make sure the shoulder bolt between the boom and the mast is securely fastened and that the cotter pin is present. | | | x |
| 14) Inspect all weld sites for cracking or separation. | | | x |
| 15) Make sure that all nuts and locknuts of the base open/close mechanism are securely fastened and the ball joints are in good condition. | | | x |
| 16) Check all bolts, nuts and locknuts to ensure they are tight. | | | x |
| 17) Check if the leg pivot bolts are secured with locknuts; tighten, if necessary. | | | x |
| 18) Make sure that the straight section of both legs is perpendicular to the base, in closed position. | | | x |
| 19) If the product does not work as intended, immediately contact your local ArjoHuntleigh vendor for support. | | | x |
| 20) Check that the Spreader Bar flange bushings, pivot bolt and welds are in good condition. | | | x |
| 21) Check the condition of the friction discs and bushings of the DPS within the pivot points. If found worn and/or damaged, parts must be replaced. | | | x |
| 22) When the friction discs and bushings of the DPS have been checked/replaced, reset friction assembly to support a 5.4 kg (12 1b) load at the handle. | | | x |

* Time period indicated by the Hour meter.

Troubleshooting

| Lift Trouble | Resolution |
|--|---|
| Hand control does not respond. | <ul style="list-style-type: none"> • Check the red emergency stop button on the control box. • Check the connector on hand control cord. • Check the battery condition (replace with a fully charged battery pack). |
| UP and DOWN buttons on control box do not respond. | <ul style="list-style-type: none"> • Check the red emergency stop button on the control box. • Check the battery condition (replace with a fully charged battery pack). |
| Actuator does not respond. | <ul style="list-style-type: none"> • Check the red emergency stop button on control box. • Check if the battery is installed correctly and fully charged. Test with a new, fully-charged battery pack. • Check if the hand control is connected. • Check if control box is in automatic cut-out mode, make sure boom is not obstructed or overloaded. |
| Audible “beep” is heard from the control box. | <ul style="list-style-type: none"> • Battery is low. Replace with a freshly charged battery pack. |
| Actuator “stalls” during lift. | <ul style="list-style-type: none"> • Battery is low. Replace with a freshly charged battery. Make sure not to exceed the lifting capacity. |
| Battery Trouble | Resolution |
| Yellow indicator light does not go off after several hours of charging time. | <ul style="list-style-type: none"> • Internal batteries need replacing. Call ArjoHuntleigh for replacement. |
| Battery pack indicates it is fully charged when in the charger, but when placed in the lift, will only do a few lifts. | <ul style="list-style-type: none"> • Replace de battery.* |

(*) Generally, a humming noise coming from the actuator indicates low battery power.

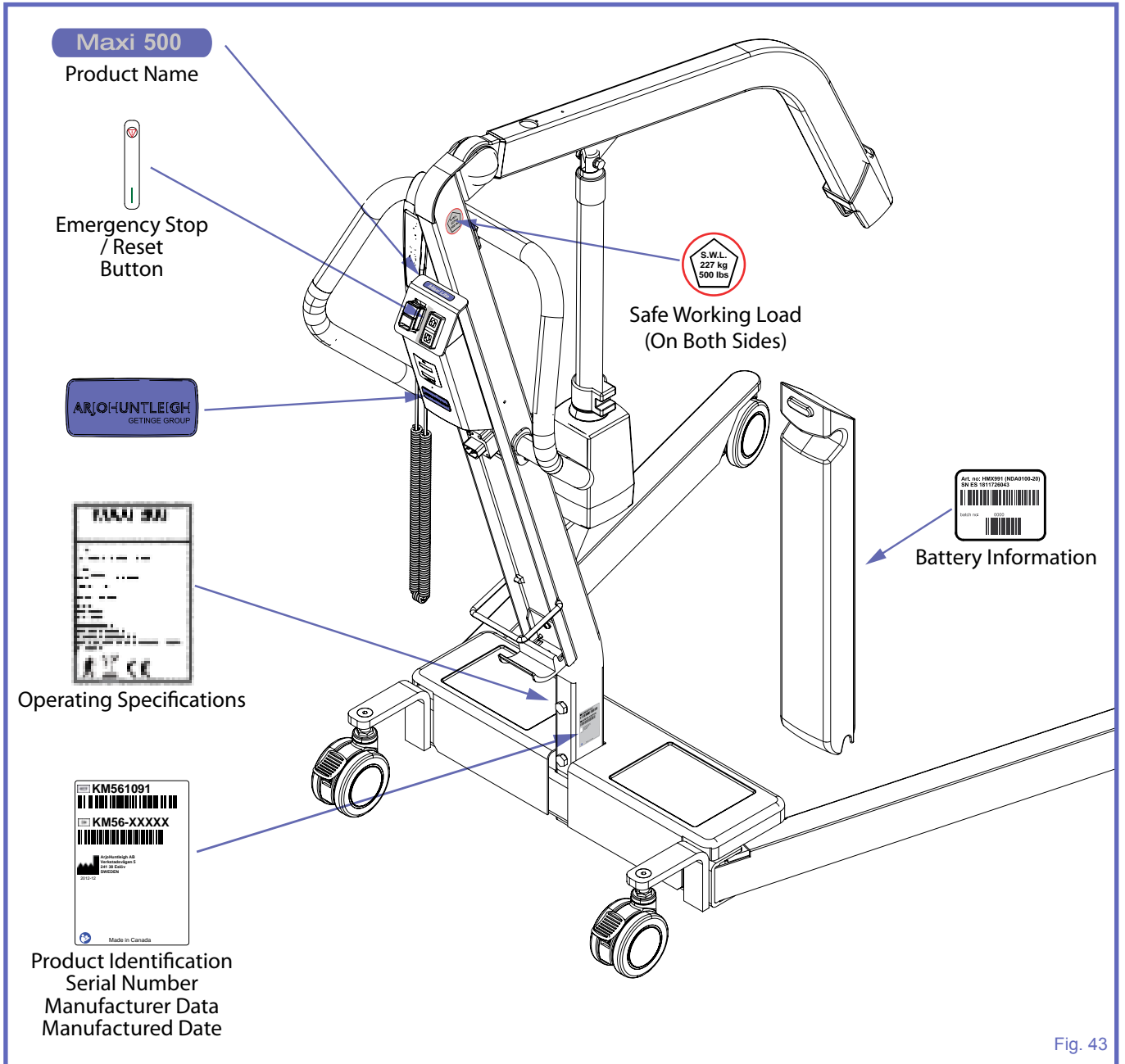
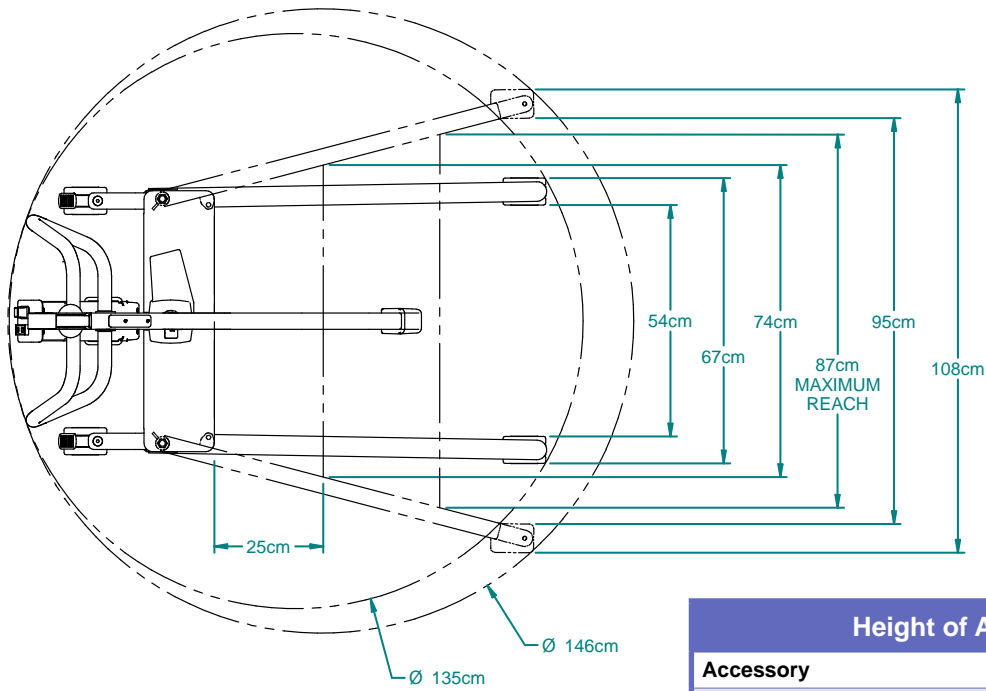

Fig. 43

Technical Specifications

| PRODUCT INFORMATION | | MAXI500 (KM56XXXX) |
|--|--|--------------------|
| Total weight | 45 kg (100 lb) | |
| Battery pack weight | < 5 kg (11 lb) | |
| Lifting capacity | 227 kg (500 lb) | |
| Minimum door requirement | 700 mm (27.5 in) | |
| MECHANICAL | | |
| IP rating control lift | Lift: Refer to product label Hand Control : IPX7 | |
| Operating forces of controls | Hand Control: < 5 N | |
| Sound power level | < 65 dBA | |
| ELECTRICAL | | |
| Battery Type | Rechargeable (Sealed Lead-Acid) | |
| Battery Capacity | 24V, 4Ah | |
| Battery charger input | (NDA8200): 100 to 240 Vac / 50-60 Hz / 50VA | |
| Battery charger output | 24 Vdc, 1A, 24VA | |
| Protection class | Class II, double insulated | |
| Up and down current limiting | 10 A | |
| Duty cycle | 10%, 6 min / hour, 1 min continuous | |
| Protection against electrical shock | Refer to product label | |
| <p>The MAXI500 meets the requirements of Electromagnetic Compatibility (EMC) as stated in clause 12.5 of the Medical Devices Directive 93/42/EEC.</p> <p>The MAXI500 conforms to ISO 10535: 2006, AAMI ES60601-1, CSA C22#60601-1, IEC 60601-1, IEC 60601-1-11:2010, CAN/CSA C22.2 No 601.1-M90, UL 60601-1.</p> | | |
| <p>WARNING: Radio transmitting devices such as mobile telephones, two-way radios, etc., should never be used near the MAXI500, since they can interfere with the function of the lift. Cables from potentially strong sources of electromagnetic fields should not be placed near the unit.</p> | | |
| DIGITAL SCALE (optional) | | |
| Weight range | 227 kg (500 lb) | |
| Display resolution and type | 0.1 kg (0.1 lb), liquid crystal display | |
| Accuracy | 0.1% ±1 digit of Reading | |
| Power Supply | 9 volt Battery | |
| Battery Life | Approximately 3000 readings | |
| ENVIRONMENTAL CONDITIONS | | |
| Ground Requirement | Maximum Slope: 1° Surface condition: Flat hard surface | |
| Ambient temperature range (lift, batteries) | Operation: 5° to 40°C (+41 to +104 F) Storage: - 25 to 70°C (-13 to 158F) | |
| Relative humidity range | Operation: 15 to 93%, non-condensing Storage: < 93%, non-condensing | |
| Atmospheric pressure range | Operation: 795 hPa to 1060 hPa (2000 m max) Storage: 500 hPa to 1060 hPa | |
| <p>WARNING: Product is not suitable in the presence of flammable anaesthetic mixture with air or oxygen, or with nitrous oxide.</p> | | |
| RECYCLING | | |
| Battery | Sealed lead-acid, rechargeable, recyclable | |
| Package | Cardboard recyclable | |
| The Lift | Separated and recycled, according to the European Directive 2002/96/EG (WEEE). | |

Dimensions



Height of Accessories*

| Accessory | Height |
|---|---------|
| 700.05500 - Two-Point Spreader Bar | 6.5 cm |
| 700.05505 - Two-Point Spreader Bar with Scale | 22.5 cm |
| 700-19342 - DPS | 54.5 cm |
| 700-19341 - DPS with Scale | 60 cm |

*The height of an accessory is measured from the boom connection to the DPS rotation axis or, in the case of two-point spreader bar, the bottom of the hook.

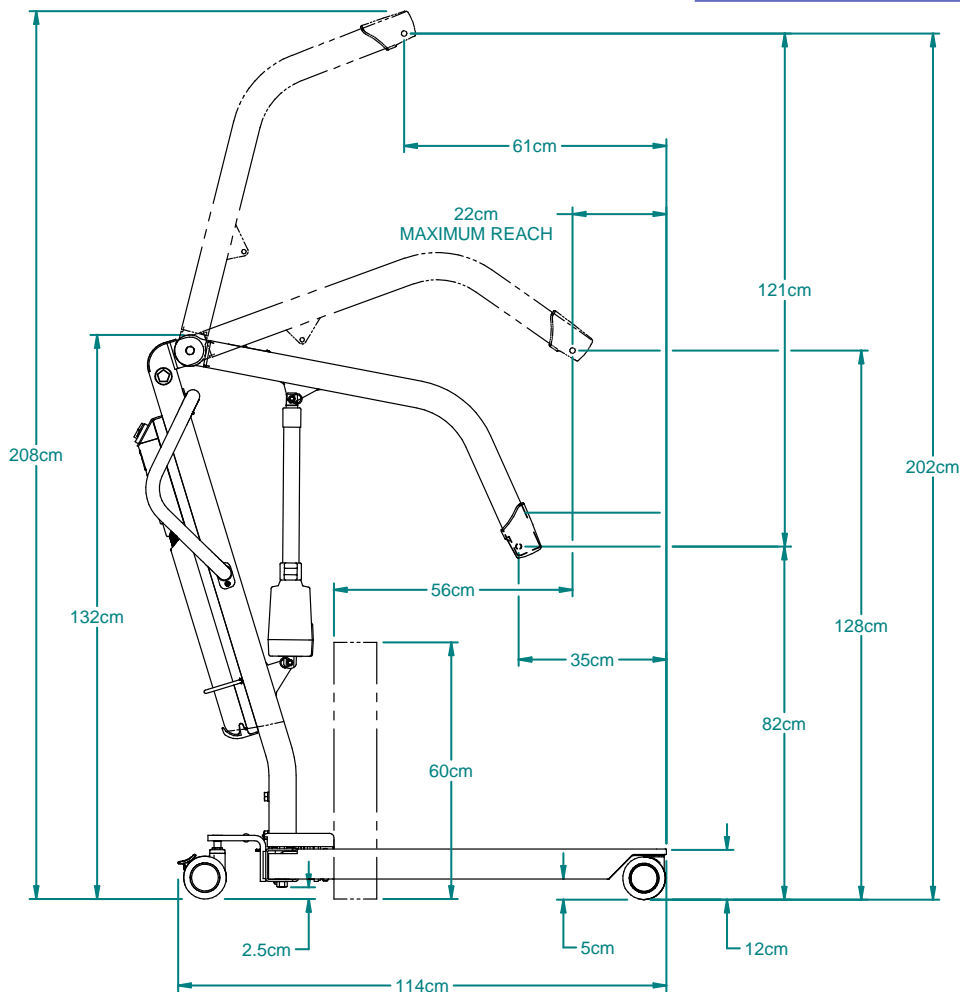

Fig. 44

Electromagnetic Compatibility

Electromagnetic Compliance

The MAXI500 has been tested for compliance with current regulatory standards regarding its capacity to block EMI (electromagnetic interference) from external sources.

Nonetheless, some procedures can help reduce electromagnetic interferences:

- Use only ArjoHuntleigh cables and spare parts to avoid increased emissions or decreased immunity which can compromise the correct functioning of the equipment.
- Ensure that other devices in patient-monitoring and/or life-support areas comply to accepted emissions standards.
- Maximize the distance between electro-medical devices. High-powered devices may produce EMI that can affect the ceiling lift. Refer to separation distance table further on in this document.

For more information on how to manage the unit's RF electromagnetic environment, please consult the AMI TIR 18-1997 - Guidance on Electromagnetic Compatibility of Medical Devices for Clinical/Biomedical Engineers.

Electromagnetic Emissions

| Guidance and Manufacturer's Declaration - Electromagnetic Emissions - For all Equipment and Systems | | |
|---|----------------|--|
| The MAXI500 is intended for use in the electromagnetic environment indicated below. The customer or the user of the MAXI500 should assure that it is used in such an environment. | | |
| Emissions test | Compliance | Electromagnetic environment - guidance |
| RF emissions CISPR 11 | Group 1 | The MAXI500 uses RF energy only for its internal function. Therefore, its RF emissions are very low and are not likely to cause any interference in nearby electronic equipment. |
| RF emissions CISPR 11 IEC 61000-3-2 | Class B | The MAXI500 is suitable for use in all establishments, including domestic establishments and those directly connected to the public low-voltage power supply network that supplies buildings used for domestic purposes. |
| Harmonic emissions | Not applicable | |
| Voltage fluctuations/flicker emissions IEC 61000-3-3 | Not applicable | |

Electromagnetic Immunity

Guidance and Manufacturer's Declaration - Electromagnetic Immunity - For all Equipment and Systems

The MAXI 500 is intended for use in electromagnetic environment specified below. The customer or the user of the MAXI 500 should assure that it is used in such an environment.

| Immunity test | IEC 60601 test level | Compliance level | Electromagnetic environment - guidance |
|--|--|----------------------------|---|
| Electrostatic discharge (ESD) IEC 61000-4-2 | ±6 kV contact ±8 kV air | ±6 kV contact ±8 kV air | Floors should be wood, concrete or ceramic tile. If floors are covered with synthetic material, the relative humidity should be at least 30%. |
| Electrical fast transient/burst IEC 61000-4-4 | ±2 kV for power supply lines ±1 kV for input/output lines | Not applicable | Mains power quality should be that of a typical commercial or hospital environment. |
| Surge IEC 61000-4-5 | ±1 kV differential mode ±2 kV for input/output | Not applicable | |
| Voltage dips, short interruptions and voltage variations on power supply input lines IEC 61000-4-11 | <5% UT (>95% dip in UT) for 0.5 cycle 40% UT (60% dip in UT) for 5 cycles 70% UT (30% dip in UT) for 25 cycles <5% UT (>95% dip in UT) for 5 sec. | Not applicable | |
| Power frequency (50/60 Hz) magnetic field | 3 A/m | 3 A/m | Power frequency magnetic fields should be at levels characteristic of a typical location in a typical commercial or hospital environment. |

NOTE: UT is the AC mains voltage prior to application of the test level.

(continued)

| Guidance and Manufacturer's Declaration - Electromagnetic Immunity - For Equipment and Systems that are Not Life-Supporting | | | |
|--|--------------------------------|--------------------------------|--|
| Immunity test | IEC 60601 test level | Compliance level | Electromagnetic environment - guidance |
| Conducted RF IEC 61000-4-6 | 3 Vrms 150 kHz to 80 Mhz | 3 Vrms 150 kHz to 80 Mhz | <p>Portable and mobile RF communications equipment should be used no closer to any part of the MAXI500, including cables, than the recommended separation distance calculated from the equation applicable to the frequency of the transmitter.</p> <p>Recommended separation distance</p> $d = \left[\frac{3.5}{3} \right] \sqrt{P} \quad 150 \text{ KHz to } 80 \text{ MHz}$ $d = \left[\frac{3.5}{10} \right] \sqrt{P} \quad 80 \text{ MHz to } 800 \text{ MHz}$ $d = \left[\frac{7}{10} \right] \sqrt{P} \quad 800 \text{ MHz to } 2.5 \text{ GHz}$ |
| Radiated RF IEC 61000-4-3 | 3 V/m 80 MHz to 2.5 GHz | 10 V/m 80 MHz to 2.5 GHz | <p>where P is the maximum output power rating of the transmitter in watts (W) according to the transmitter manufacturer and d is the recommended separation distance in meters.</p> <p>Field strengths from fixed RF transmitters, as determined by an electromagnetic site survey, (a) should be less than the compliance level in each frequency range. (b)</p> <p>Interference may occur in the vicinity of equipment marked with the following symbol:</p>  |
| NOTE 1: At 80 MHz and 800 MHz, the higher frequency range applies. | | | |
| NOTE 2: These guidelines may not apply in all situations. Electromagnetic propagation is affected by absorption and reflection from structures, objects and people. | | | |
| (a) Field strengths from fixed transmitters, such as base stations for radio (cellular/cordless) telephones and land mobile radios, amateur radio, AM and FM radio broadcast and TV broadcast cannot be predicted theoretically with accuracy. To assess the electromagnetic environment due to fixed RF transmitters, an electromagnetic site survey should be considered. If the measured field strength in the location in which the MAXI500 is used exceeds the applicable RF compliance level above, the MAXI500 should be observed to verify normal operation. If abnormal performance is observed, additional measures may be necessary, such as reorienting or relocating the MAXI500. | | | |
| (b) Over the frequency range 150 kHz to 80 MHz, field strengths should be less than 3 V/m. | | | |

(continued)

**Recommended Separation Distance Between -
Portable and Mobile RF Communications Equipment and the MAXI500 for Equipment
and Systems that are not Life-Supporting**

Recommended separation distances between portable and mobile RF communications equipment and the MAXI500.

The MAXI500 is intended for use in electromagnetic environment in which radiated RF disturbances are controlled. The customer or the user of the MAXI500 can help prevent electromagnetic interference by maintaining a minimum distance between portable and mobile RF communication equipment (transmitters) and the MAXI500 as recommended below, according to the maximum output power of the communications equipment.

| Rated maximum output power of transmitter W | Separation distances according to frequency of transmitter m | | |
|---|---|--|--|
| | 150 KHz to 80 MHz | 80 MHz to 800 MHz | 800 MHz to 2.5 GHz |
| | $d = \left[\frac{3.5}{3} \right] \sqrt{P}$ | $d = \left[\frac{3.5}{10} \right] \sqrt{P}$ | $d = \left[\frac{7}{10} \right] \sqrt{P}$ |
| 0.01 | 0.12 | 0.12 | 0.24 |
| 0.1 | 0.38 | 0.38 | 0.74 |
| 1 | 1.2 | 1.2 | 2.4 |
| 10 | 3.8 | 3.8 | 7.4 |
| 100 | 12 | 12 | 24 |

For transmitters rated at a maximum output power not listed above, the recommended separation distance *d* in metres (m) can be estimated using the equation applicable to the frequency of the transmitter, where *P* is the maximum output power rating of the transmitter in watts (W) according to the transmitter manufacturer.

NOTE 1: At 80 MHz and 800 MHz, the separation distance for the higher frequency range applies.

NOTE 2: These guidelines may not apply in all situations. Electromagnetic propagation is affected by absorption and reflection from structures, objects and people.

Dimensions

AUSTRALIA

ArjoHuntleigh Pty Ltd
78, Forsyth street
O'Connor
AU-6163 Western Australia
Tel: +61 89337 4111
Free: +1 800 072 040
Fax: + 61 89337 9077

BELGIQUE / BELGIË

ArjoHuntleigh NV/SA
Evenbroekveld 16
B-9420 ERPE-MERE
Tél/Tel: +32 (0) 53 60 73 80
Fax: +32 (0) 53 60 73 81
E-mail: info@arjohuntleigh.be

CANADA

ArjoHuntleigh
90 Matheson Boulevard West
Suite 300
MISSISSAUGA, ON, L5R 3R3
Tel/Tél: +1 905 238 7880
Free: +1 800 665 4831 Institutional
Free: +1 800 868 0441 Home Care
Fax: +1 905 238 7881
E-mail: info.canada@arjohuntleigh.com

ČESKÁ REPUBLIKA

ArjoHuntleigh s.r.o.
Hlinky 118
CZ- 603 00 BRNO
Tel: +420 549 254 252
Fax: +420 541 213 550

DANMARK

ArjoHuntleigh A/S
Vassingerødvej 52
DK-3540 LYNGE
Tel: +45 49 13 84 86
Fax: +45 49 13 84 87
E-mail: info.dk@arjohuntleigh.com

DEUTSCHLAND

ArjoHuntleigh GmbH
Peter-Sander-Strasse 10
D-55252 MAINZ-KASTEL
Tel: +49 (0) 6134 186 0
Fax: +49 (0) 6134 186 160
E-mail: info-de@arjohuntleigh.com

ΕΛΛΑΔΑ

C. Psimitis Co Ltd
Dimitriou Andr. 59
GR-16121 KAISARIANI ATTIKIS
Τηλ: 21 0724 36 68
Φάξ: 21 0721 55 53

ESPAÑA

ArjoHuntleigh Ibérica S.L.
Ctra. de Rubí, 88 1ª planta - A1
08173 Sant Cugat del Vallés
ES- BARCELONA 08173
Tel: +34 93 583 11 20
Fax: +34 93 583 11 22
E-mail: info.es@arjohuntleigh.com

FAR EAST

ARJO Far East Limited
Unit 3A, 4/F., block B Hoi Luen
Industrial Centre
55 Hoi Yuen Road,
Kwun Tong, Kowloon
HONG KONG
Tel: +852 2508 9553
Fax: +852 2508 1416

FRANCE

ArjoHuntleigh SAS
2 Avenue Alcide de Gasperi
CS 70133
59436 RONCQ CEDEX
Tél: +33 (0) 3 20 28 13 13
Fax: +33 (0) 3 20 28 13 14
E-mail : info.france@arjohuntleigh.com

INTERNATIONAL

ArjoHuntleigh International Ltd.
ArjoHuntleigh House
Houghton Hall Park
Houghton Regis
UK-DUNSTABLE LU5 5XF
Tel: +44 (0) 1582 745 800
Fax: +44 (0) 1582 745 866
E-mail:
international@ArjoHuntleigh.com

ITALIA

ArjoHuntleigh S.p.A.
Via di Tor Vergata 432
00133 ROMA - ITALIA
Tel: +39 (0) 6 87426211
Fax: +39 (0) 6 87426222
E-mail: Italy.promo@arjohuntleigh.com

NEDERLAND

ArjoHuntleigh Nederland BV
Biezenwei 21
4004 MB TIEL
Postbus 6116
4000 HC TIEL
Tel: +31 (0) 344 64 08 00
Fax: +31 (0) 344 64 08 85
E-mail: info.nl@arjohuntleigh.com

NEW ZEALAND

ArjoHuntleigh Ltd
41 Vestey Drive
Mount Wellington
AUCKLAND 1060
Tel: +64 (0) 9 573 5344
Free Call: 0800 000 151
Fax: +64 (0) 9 573 5384
E-mail: nz.info@ArjoHuntleigh.com

NORGE

ArjoHuntleigh Norway AS
Ryenstubben 2
NO-0679 OSLO
Tel: +47 22 08 00 50
Faks: +47 22 08 00 51
E-mail: no.kundeservice@arjohuntleigh.com

POLSKA

ArjoHuntleigh Polska Sp. z o.o.
ul. Ks Piotra Wawrzyniaka 2
PL 62-052 KOMORNIKI (Poznan)
Tel: +48 61 662 15 50
Fax: +48 61 662 15 90
E-mail: arjo@arjohuntleigh.com

PORTUGAL

ArjoHuntleigh em Portugal:
MAQUET Portugal, Lda. (Distribuidor Exclusivo)
Rua Poeta Bocage n.º 2 - 2G
1600-233 Lisboa, Portugal
Tel: +351 214 189 815
Fax: +351 214 177 413
E-mail: Portugal@arjohuntleigh.com

SUISSE / SCHWEIZ

ArjoHuntleigh AG
Fabrikstrasse 8
Postfach
4614 Hägendorf,
Tél/Tel: +41 (0) 61 337 97 77
Fax: +41 (0) 61 311 97 42

SUOMI

ArjoHuntleigh OY
Vanha Porvoontie 229
FI-01380 VANTAA
Puh: +358 9 4730 4320
Faksi: +358 9 4730 4999

SVERIGE

ARJO Scandinavia AB
Verkstadsvägen 5
Box 61
SE-241 21 ESLÖV
Tel: +46 (0) 10-335 45 00
Fax: +46 (0) 413-138 76
E-mail: kundservice@arjohuntleigh.com

UNITED KINGDOM

ArjoHuntleigh UK
ArjoHuntleigh House
Houghton Hall Park
Houghton Regis
UK-DUNSTABLE LU5 5XF
Tel: +44 (0) 1582 745 700
Fax: +44 (0) 1582 745 745
E-mail:
sales.admin@ArjoHuntleigh.com

USA

ArjoHuntleigh Inc.
2349 W Lake Street Suite 250
Addison, IL 60101
Tel: +1 630 307 2756
Free: +1 800 323 1245 Institutional
Free: +1 800 868 0441 Home Care
Fax: +1 630 307 6195
E-mail: us.info@ArjoHuntleigh.com

ÖSTERREICH

ArjoHuntleigh GmbH
Dörrstrasse 85
AT-6020 INNSBRUCK
Tel: +43 (0) 512 204 160 0
Fax: +43 (0) 512 204 160 75

ARJOHUNTLEIGH

GETINGE GROUP

GETINGE GROUP is a leading global provider of products and systems that contribute to quality enhancement and cost efficiency within healthcare and life sciences. We operate under the three brands of **ArjoHuntleigh**, **GETINGE** and **MAQUET**. **ArjoHuntleigh** focuses on patient mobility and wound management solutions. **GETINGE** provides solutions for infection control within healthcare and contamination prevention within life sciences. **MAQUET** specializes in solutions, therapies and products for surgical interventions and intensive care.

www.ArjoHuntleigh.com

 **ArjoHuntleigh AB**
Verkstadsvägen 5
241 38 Eslöv
SWEDEN

